

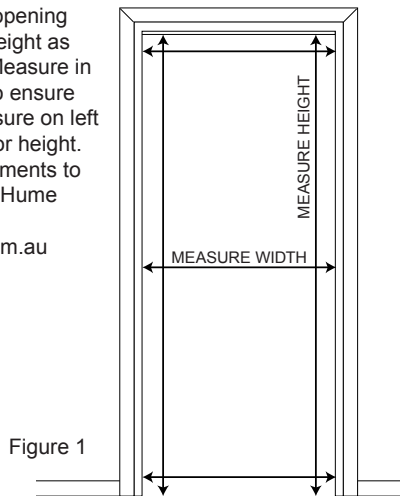

INSTRUCTIONS FOR HOW TO INSTALL HINGED DOORS

Follow these easy steps for installation

1 Measure your opening for width and height as shown (Figure 1). Measure in 3 places for width to ensure even spacing. Measure on left and right of frame for height. Use these measurements to purchase your new Hume door at www.humedoors.com.au



2 Transfer your door opening measurements taken in **step 1** to your new Hume door. Your door may require trimming to fit the opening. A maximum of 3mm may be trimmed from any edge. Figure 2 shows a power planer used to trim door.

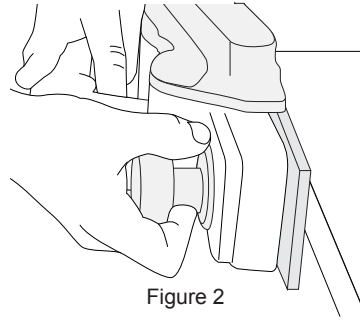

3 Place your door in the opening and then use 2 wedges to wedge the door in place (Figure 3). You may require help to move the door if it is too heavy.

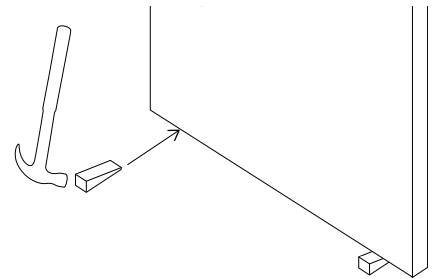

4 Purchase your preferred choice of hinges. Internal doors (non solid) require 2 hinges, while 3 or 4 hinges are needed for solid entrance doors depending on their size. With the door wedged in position measure the location for your hinges from Jamb and transfer onto door (Figure 4)

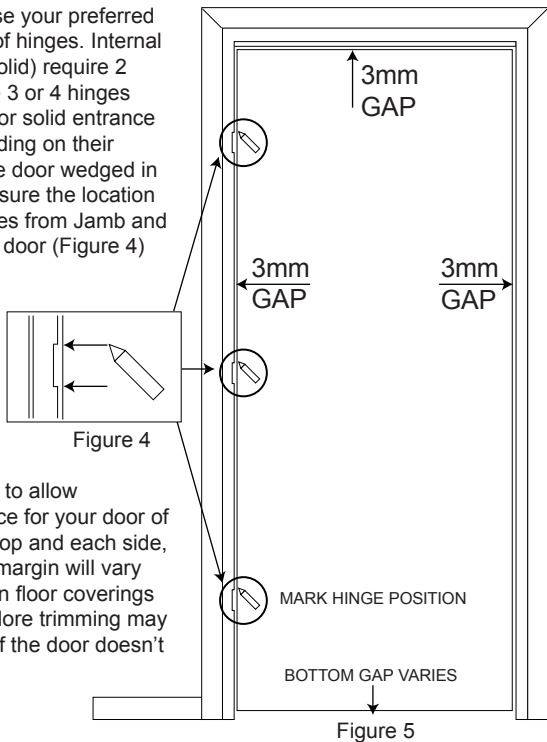

5 Be sure to allow clearance for your door of 3mm at the top and each side. The bottom margin will vary depending on floor coverings (Figure 5). More trimming may be required if the door doesn't fit correctly.

6 Place door securely on its side and transfer all measurements marked for hinges onto side of door. Using the hinge as a template trace around the hinge (Figure 6).

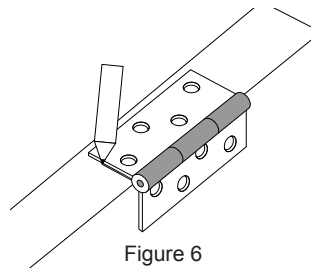

8 Seal your door, top and bottom before installation (Figure 8). This will protect your door from moisture.

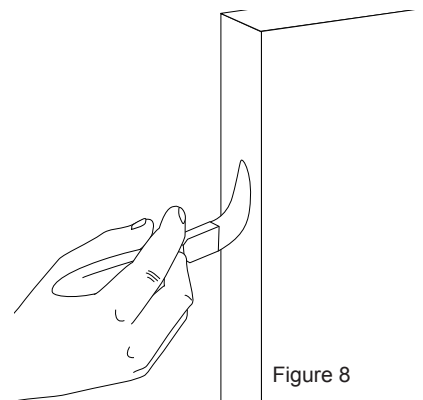

7 Chisel out for hinges (Figure 7)

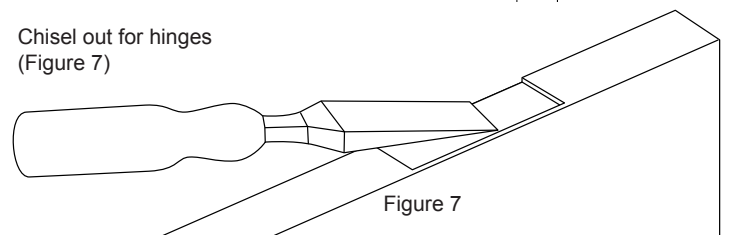

9 Stand your door in the frame to check hinge locations are correct. Using wedges adjust the door to locate the correct hinge position and screw into place.

10 Your door should swing freely, if any final adjustment is required, remove door and complete adjustments.

11 Your door is ready to have the door furniture installed and be painted. Fit door furniture as per manufacturer instructions. Paint door in accordance to Hume Doors warranty.



Scan QR code to see the video for these instructions

Hume Doors & Timber

Sydney
Ph: (02) 9794 1111
Fax: (02) 9794 1199

Brisbane
Ph: (07) 3489 6200
Fax: (07) 3489 6299

Melbourne
Ph: (03) 9799 6888
Fax: (03) 9799 9688

Adelaide
Ph: (08) 8280 2000
Fax: (08) 8280 8099

Perth
Ph: (08) 9470 1800
Fax: (08) 9472 3802

www.humedoors.com.au

Video instructions for our How To Change An Existing Door available at:
<http://www.humedoors.com.au/hume-how-to-change-a-door.php>