

INSTALLATION TOOLS

For safety while installing, it's recommended you use:

- Cut resistant gloves (if knife is used).
- Provide appropriate tools and personal protective equipment (PPE) — it's preferable to use manual tools — any power tools should be fitted with effective dust collection to capture fibres and dust and be protected by a safety switch.

ECOWOOL CEILING BATTS

For an efficient installation, the following tools are recommended:

- Sharp knife for trimming insulation
- Ladder
- Suitable clothing (see our Health and Safety Information)
- Tape measure
- Non-conductive insulation stick for positioning insulation in hard to reach areas
- Kneeling board to span ceiling framing

ECOWOOL WALL BATTS

For an efficient installation, the following tools are recommended:

- Stable working platform
- Knife
- Tape measure

CEILING INSULATION

- The building envelope must be constructed to ensure the insulation remains dry during installation and throughout the life of the building.
- Recommended to use:
 - 430mm insulation for 450mm joist centres and 580mm insulation for 600mm centres.
- To calculate the number of packs needed, determine the area (m²) to be insulated by multiplying the length by the wall width.
- The number of m² of insulation material is clearly marked on each pack.
- Divide the total area to be insulated by the m² in a pack to determine the number of packs required.
- Don't take the insulation out of the packaging until you're in a position and ready to install.

CEILING INSULATION INSTALLATION INSTRUCTION

- Before installation, gently agitate the insulation by gently shaking or bouncing it on its side until it recovers to the thickness stated on the label.
- Do not block ceiling vents and take care around downlights and other sources of heat.
- Follow the manufacturer's instructions for minimum clearances from hot inbuilt appliances.
- Start installing the insulation at the far corners of the ceiling and work your way back towards the ceiling access.
- When installing insulation between ceiling joists, ensure that you achieve a snug fit, avoiding any gaps.
- When installing insulation in truss roofs, ensure that insulation is firmly butted together to achieve a consistent layer of insulation without any gaps.
- Where required, use a sharp knife to cut the insulation to fit.
- It is important that when you cut the insulation that you avoid coming into contact with any electrical services.
- Please refer to plasterboard manufacturers for maximum ceiling load.

When installing insulation in a roof eave (i.e. where the roof joins the ceiling), make sure the insulation covers the top plate but is not in contact with the roof. It is important to maintain a 25mm gap between the roofing substrates and the insulation.

- To meet AS3999 in Australian homes a clearance of 25-50mm must be provided around the perimeter of the fitting to help heat dissipation, however the clearance should be as close to 25mm as possible to ensure maximum insulation performance.
- If the electrical wiring is already energised, before commencing insulation installation, ensure that the mains power is isolated and tagged.

When installing insulation in a roof eave (i.e. where the roof joins the ceiling), make sure the insulation covers the top plate but is not in contact with the roof. It is important to maintain a 25mm gap between the roofing substrates and the insulation.

- To meet AS3999 in Australian homes a clearance of 25-50mm must be provided around the perimeter of the fitting to help heat dissipation, however the clearance should be as close to 25mm as possible to ensure maximum insulation performance.
- If the electrical wiring is already energised, before commencing insulation installation, ensure that the mains power is isolated and tagged.

WALL INSULATION

- The building envelope must be constructed to ensure the insulation remains dry during installation and throughout the life of the building.
- To calculate the number of packs needed, determine the area (m²) to be insulated by multiplying the length by the width or wall height.
- The number of m² of insulation material is clearly marked on each pack.
- Divide the total area to be insulated by the m² in a pack to determine the number of packs required.
- Don't take the insulation out of the packaging until you're in a position and ready to install.

WALL INSULATION INSTALLATION INSTRUCTION

- If the electrical wiring is already energised, before commencing insulation installation, ensure that the mains power is isolated and tagged.
- Before installation, gently agitate the insulation by gently shaking or bouncing it on its side until it recovers to the thickness stated on the label.
- The equipment manufacturer's installation instructions/ advice in this regard must not be contravened. Statutory clearances between the equipment and thermal insulation must be maintained in accordance with relevant current Standards including AS 3999 and AS/NZS 3000:2007 (wiring rules).
- When installing insulation between framing members, ensure that you achieve a snug fit avoiding any gaps, tucks and folds.
- It is recommended that you select products that have the same thickness as the cavity. In circumstances where the cavity is deeper than the product selected, adequate support must be provided.
- Wall underlay should be installed prior to installing insulation between framing members to prevent the insulation coming into contact with the back face of the cladding and stops water leakage through the cladding.
- Make sure insulation fits snugly against top and bottom wall plates.
- For metal frame walls, install insulation according to the relevant building code. Snug fit one side of the slab into the metal C-channel and butt the other edge against the metal stud.
- Install insulation to cover the full height of the wall.
- Use off cuts to insulate small and hard to fit areas.
- Make sure all areas are insulated, behind electrical outlets, plumbing and services.
- Seal all penetrations in exterior walls with insulation or other suitable sealants.
- Complete a final check of the installation ensuring all areas have been insulated and that you have an even and consistent layer of insulation.

ELECTRIC CABLES AND EQUIPMENT

- Before ceiling insulation is installed in a building, the relevant person must ensure that the mains power is isolated and tagged.
- Metal or other conductive fasteners not to be used to install ceiling insulation.
- The equipment manufacturer's installation instructions/ advice in this regard must not be contravened. Statutory clearances between the equipment and thermal insulation must be maintained in accordance with relevant current Standards including AS 3999 and AS/NZS 3000:2007 (wiring rules).
- For more information regarding requirements for installing insulation around or near electrical cabling, heat generating appliances and recessed lighting, please refer to AS 3999.

Batts are to be installed in various ways throughout the installation – for more information on installing batts please refer to Appendix A below.

APPENDIX A

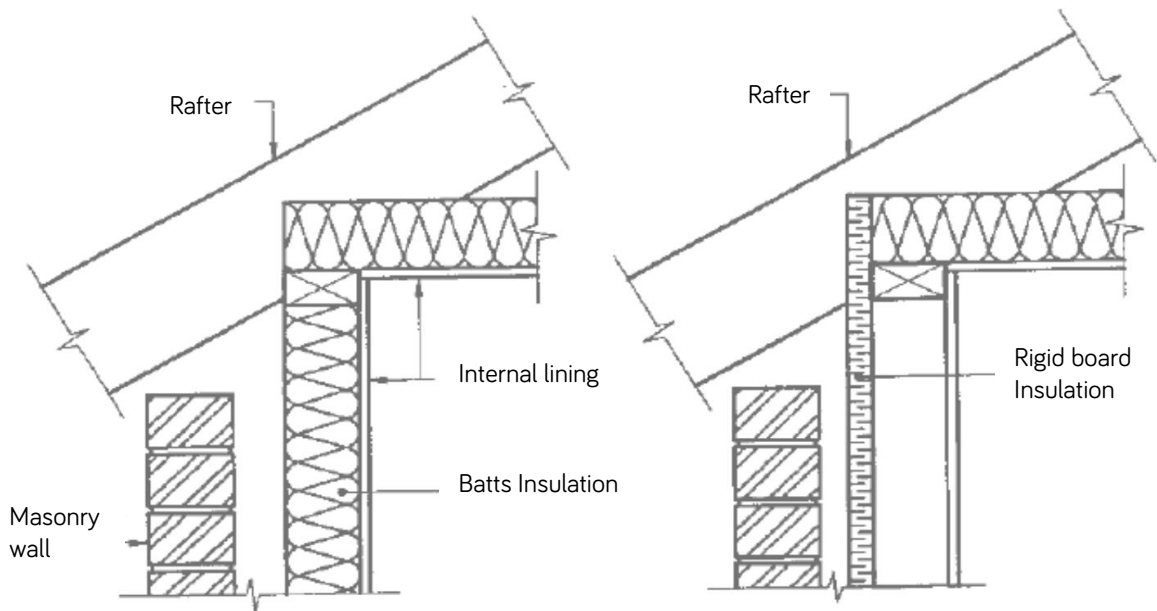

Illustration 1: Placement of thermal insulation to eliminate thermal bridging.

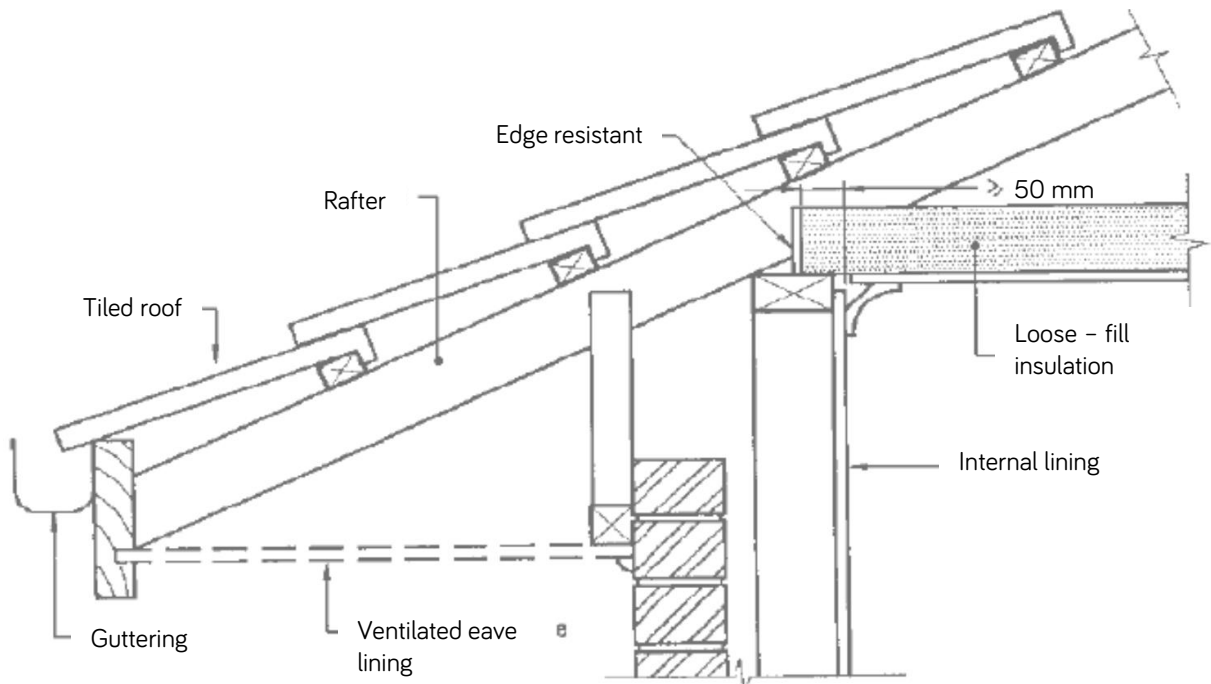

Illustration 2: Edge restraint for loose-fill insulation where eaves are ventilated (CFI)

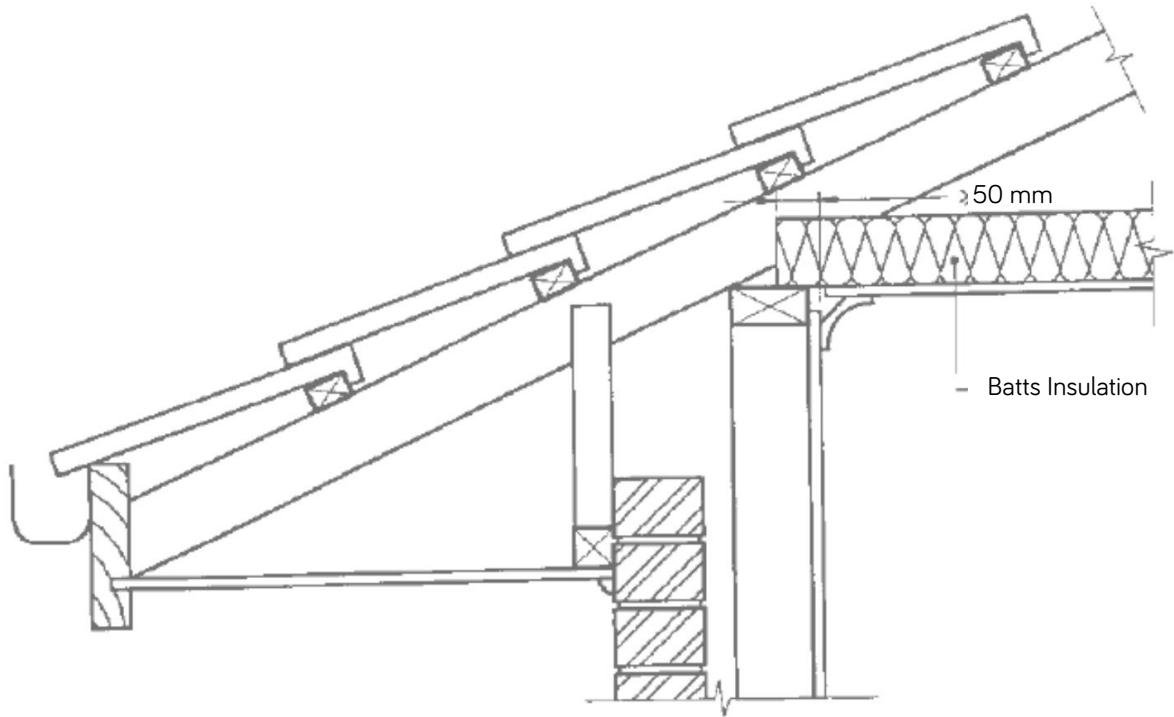

Illustration 3: Extension of ceiling insulation beyond inside face of wall.

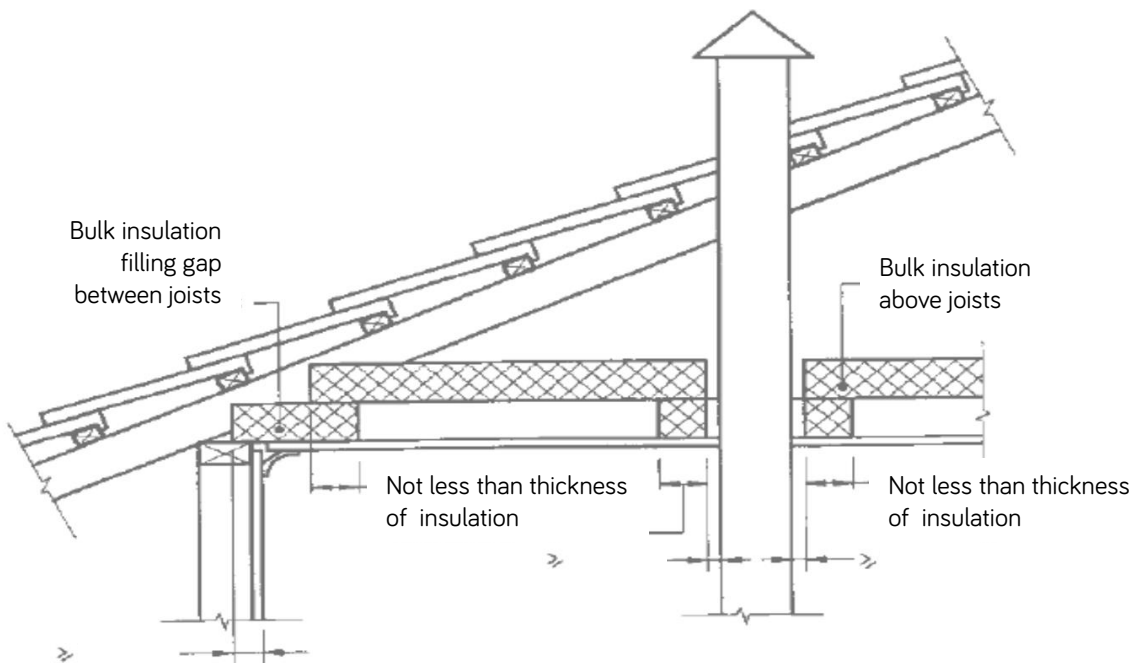

Illustration 4: Prevention of air flow below insulation installed on top of ceiling joists.

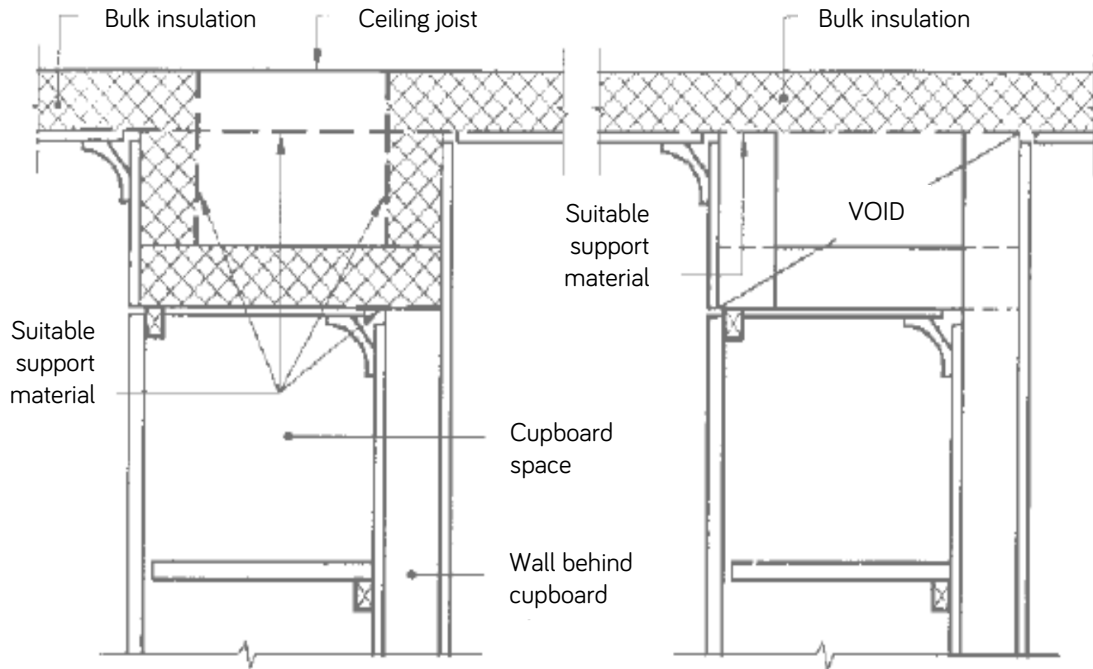
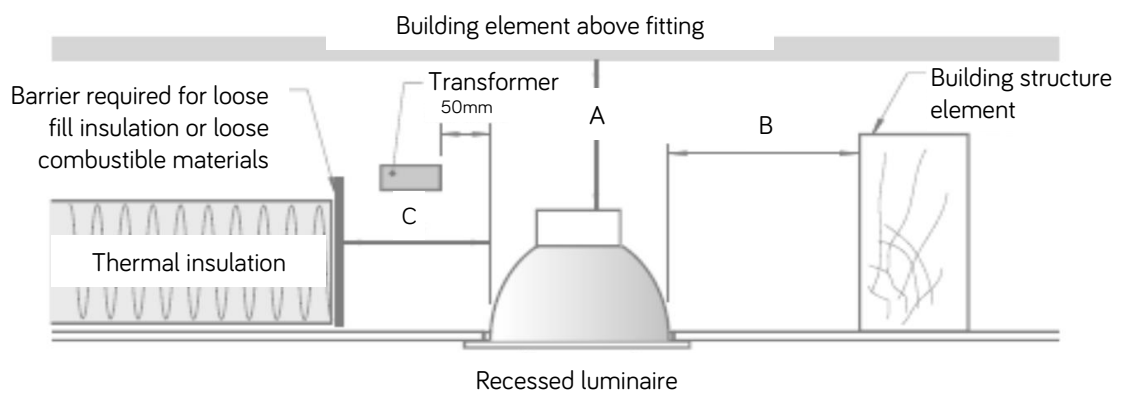

Illustration 5: Alternative treatments for drop ceilings or cavities below ceiling line.

Building structural member



Recessed luminaire

Dimension	Incandescent lamp	Halogen lamp
A - clearance above luminaire	50 mm	200 mm
B - side clearance to structural member	100 mm	200 mm
C - clearance to thermal insulation	50 mm	200 mm
D - clearance to supply transformer	50 mm	50 mm

Illustration 6: For conventional down lights clearance must be 200mm from the outer edge of each down light, when covers are not installed. Otherwise the insulation must be installed right to the edge of any covers. 50mm clearance should also be given to transformers.

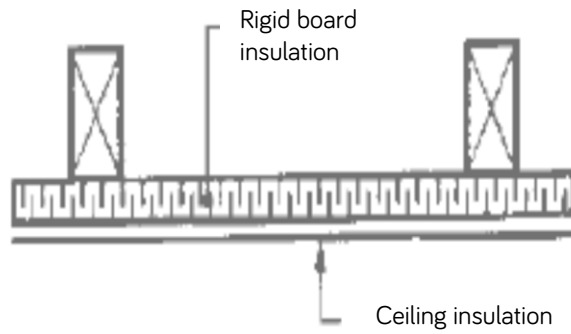

Illustration 7: Rigid board installed between ceiling joists and lining

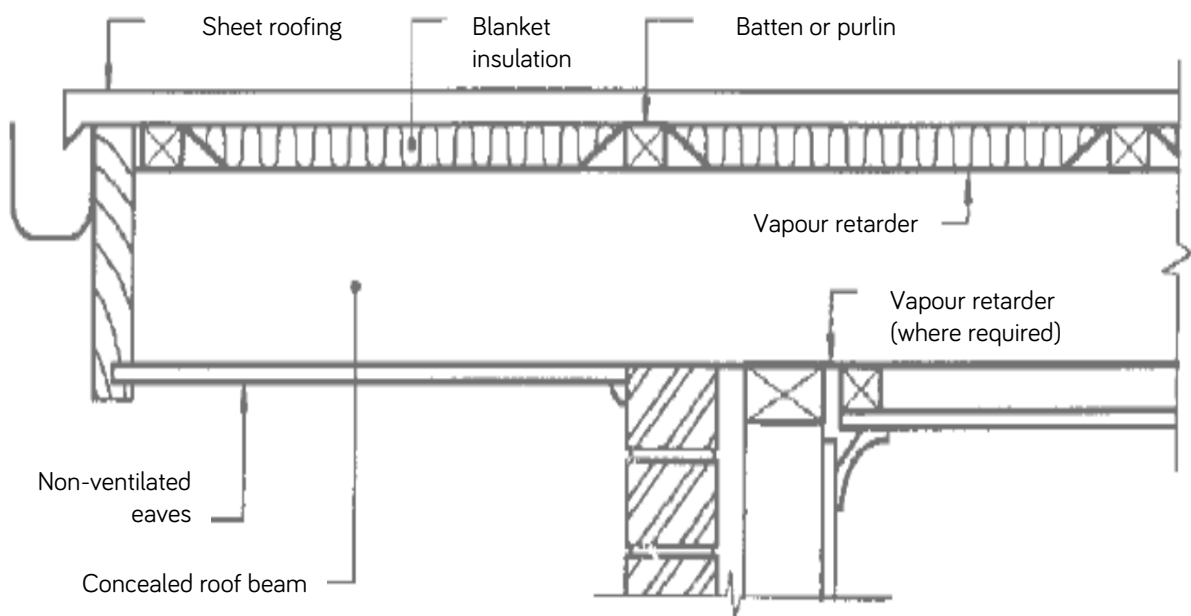

Illustration 8: Blanket insulation in contact with roof sheeting.

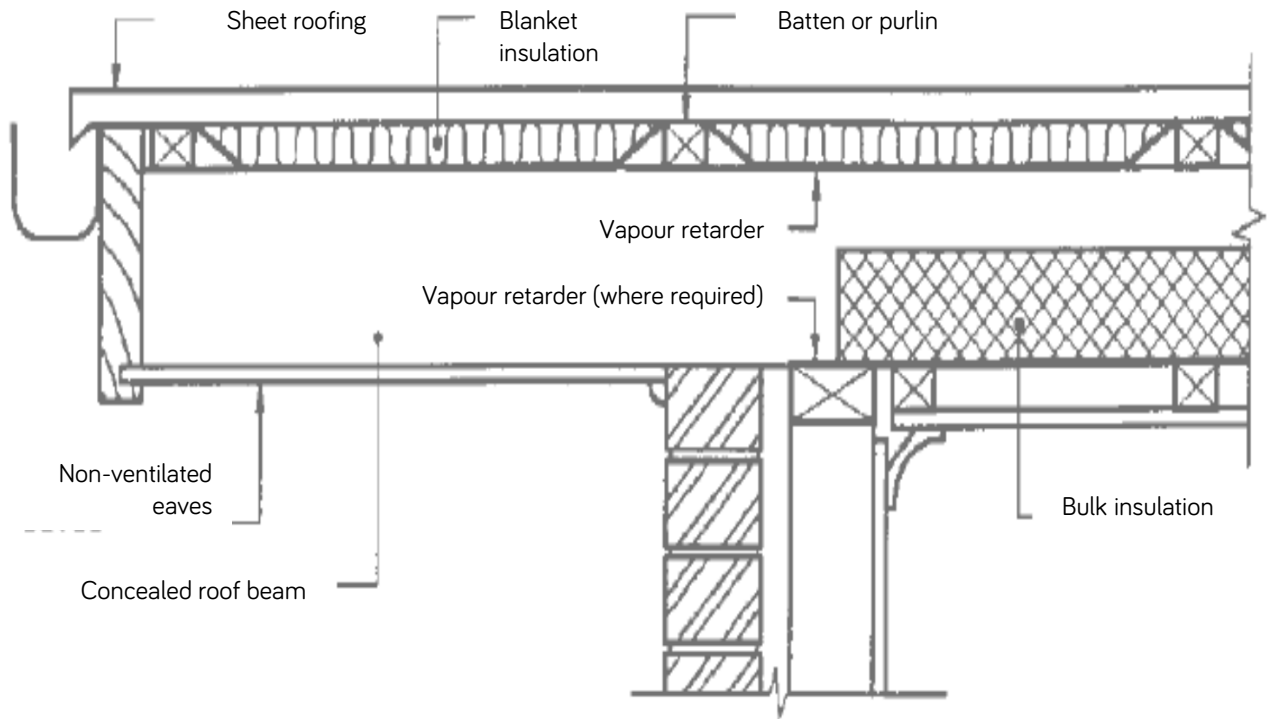

Illustration 9: Blanket insulation in contact with sheet roofing and bulk insulation on ceiling & Insulation of horizontal ceilings with flat or low pitched metal roofs

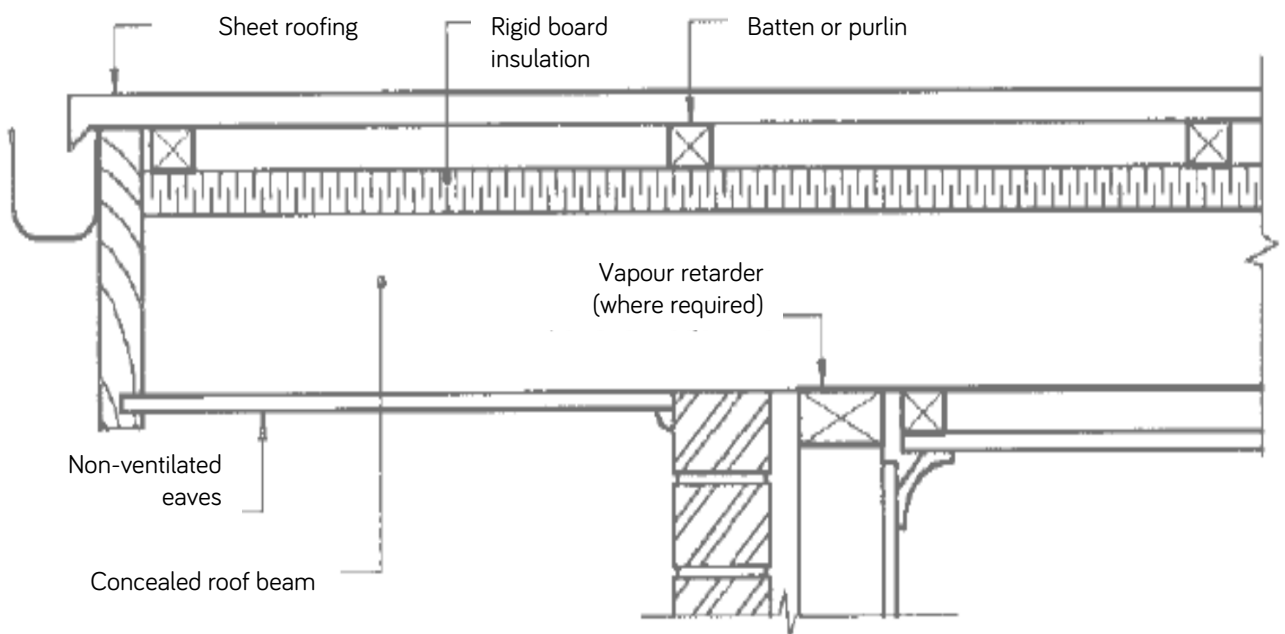

Illustration 10: Rigid board insulation beneath roofing battens.

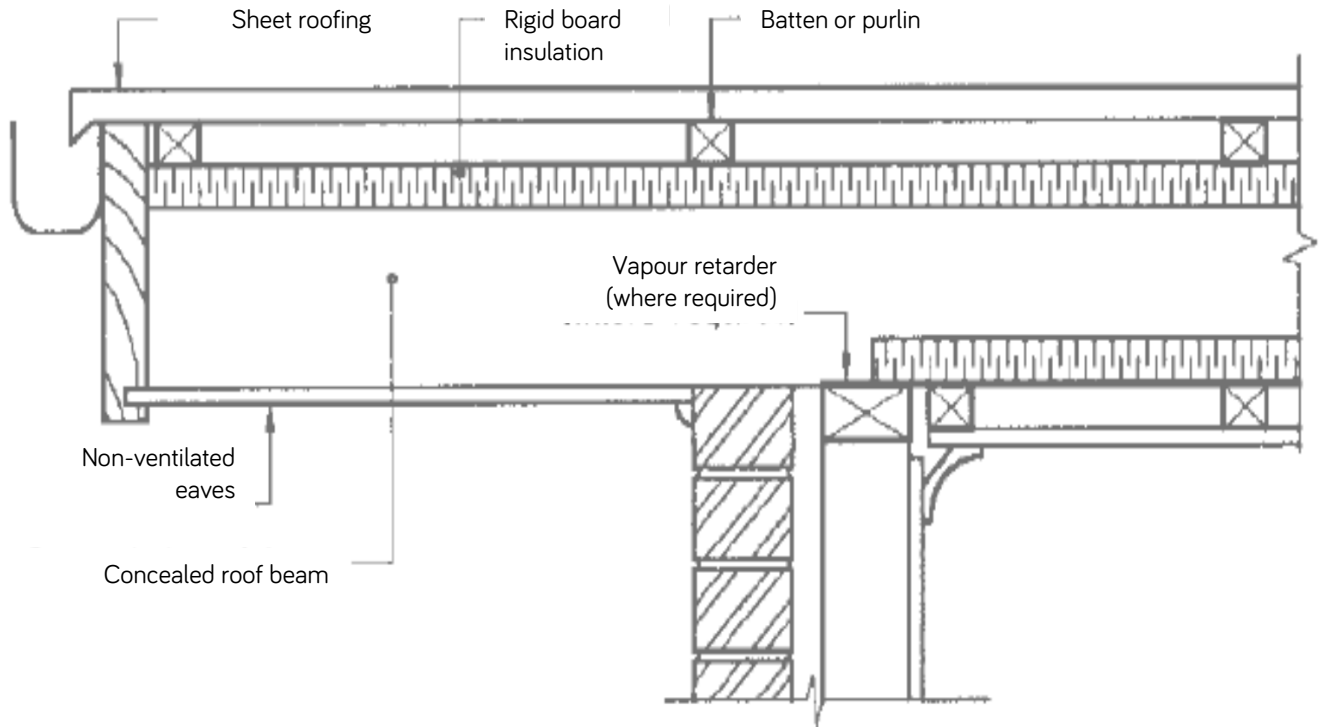

Illustration 11: Rigid board insulation beneath battens and on ceiling / Insulation of horizontal ceilings with flat or low pitched metal roofs.

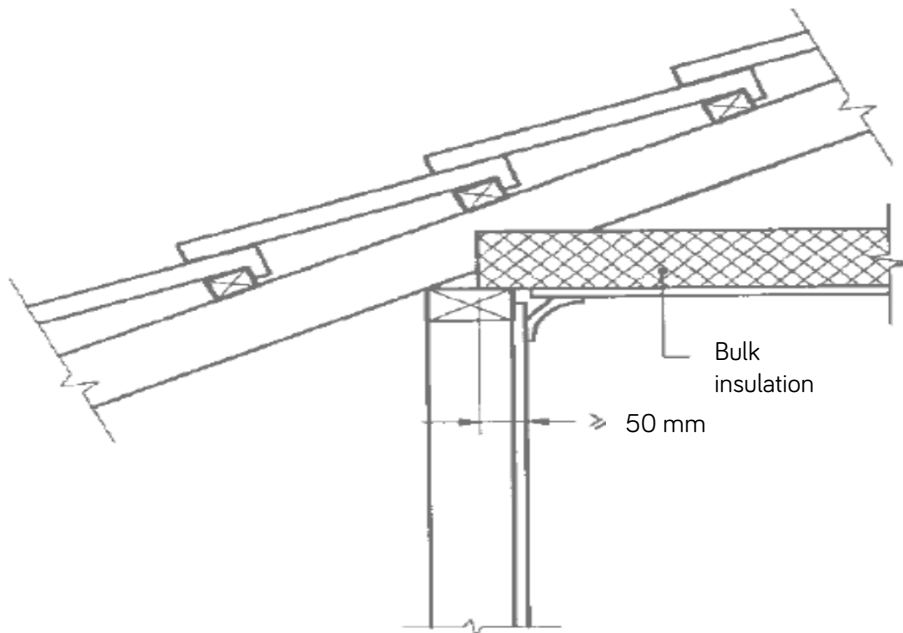

Illustration 12: Insulation of horizontal ceiling with pitched tiled roofs.

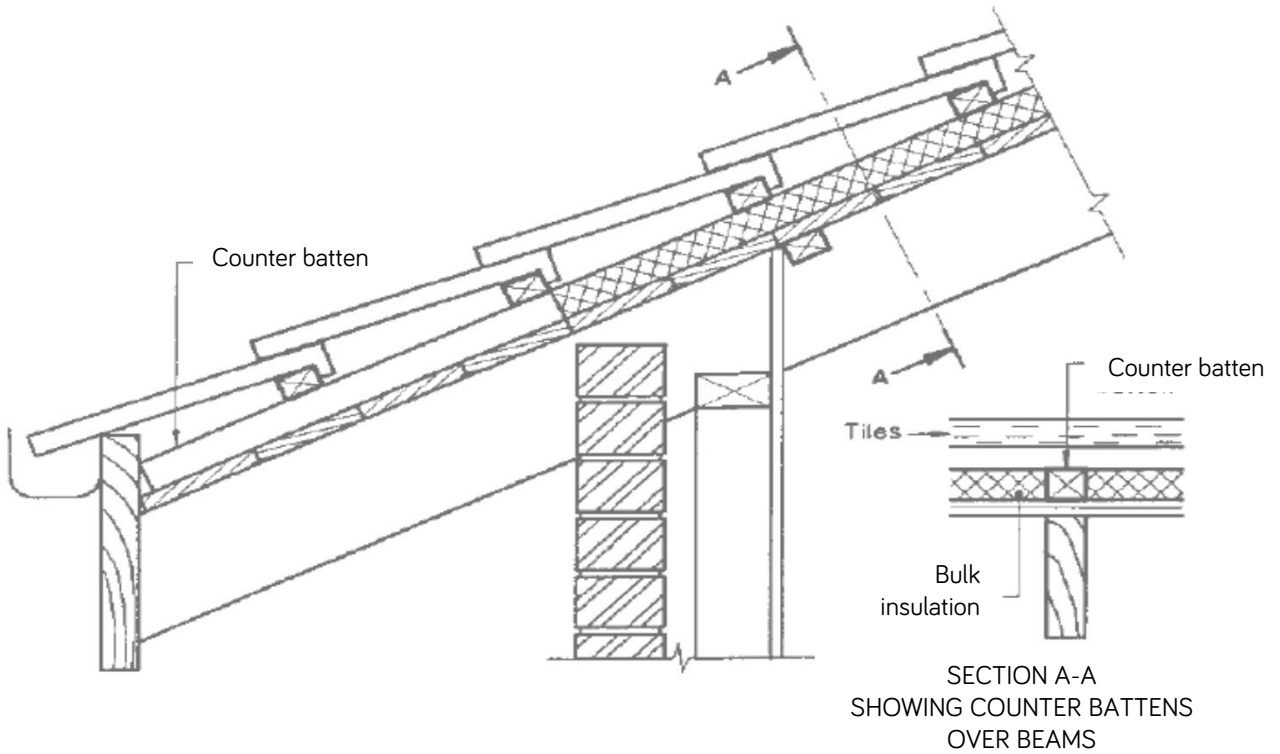

Illustration 13: Bulk Insulation between counter battens / Insulation of sloping ceiling with pitched tiled roofs.

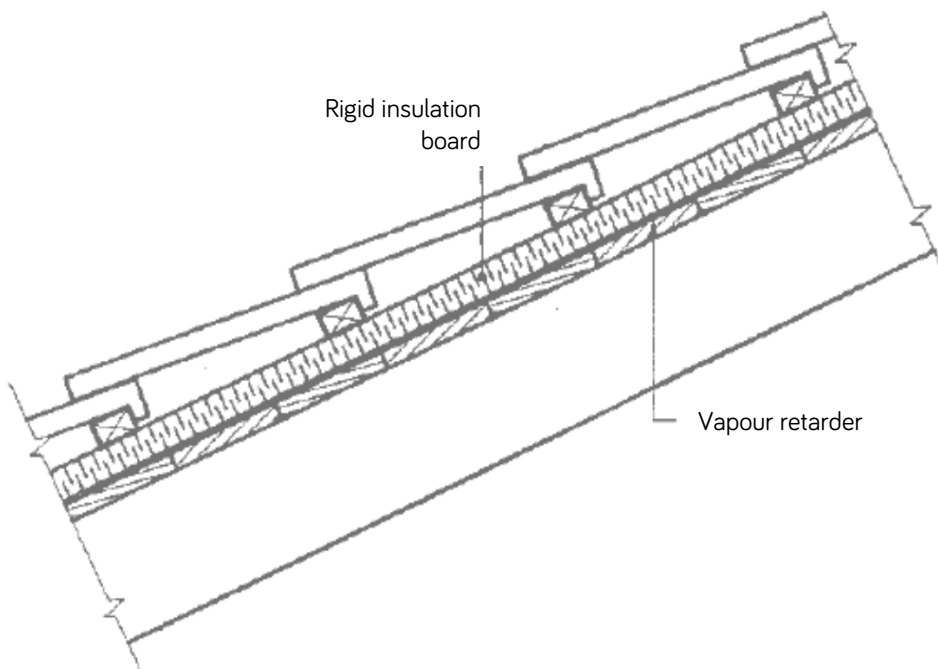

Illustration 14: Rigid board insulation directly over ceiling lining / Insulation of sloping ceiling with pitched, tiles roofs.

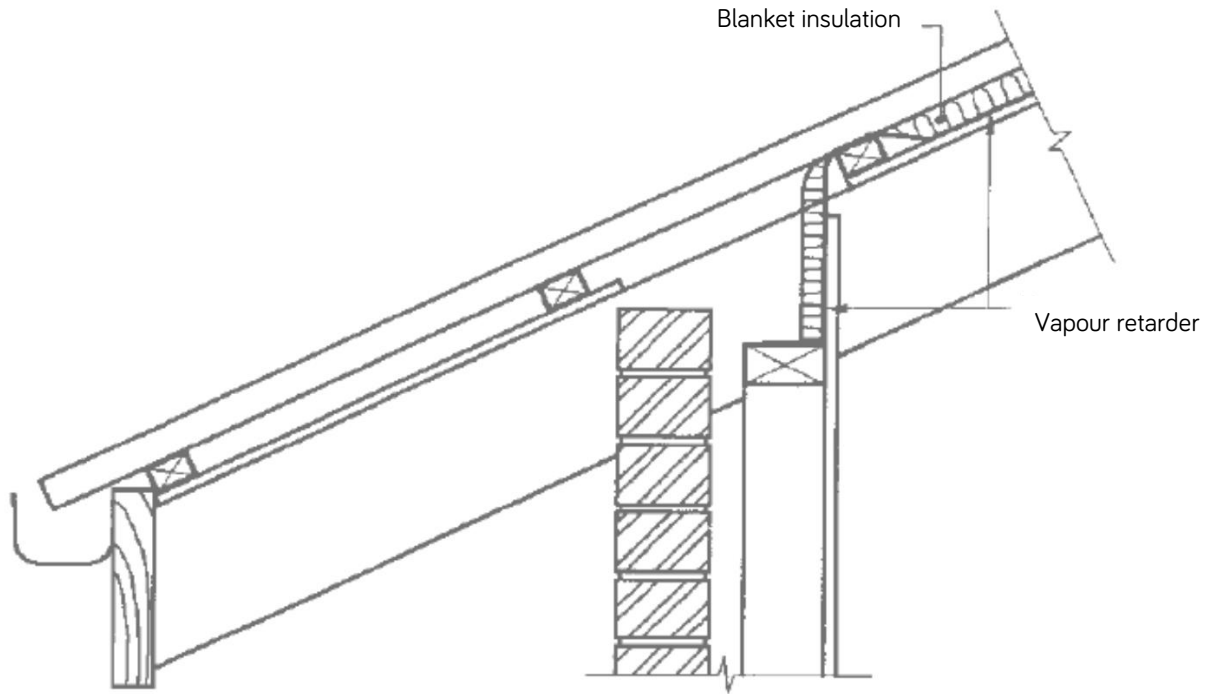

Illustration 15: Insulation of sloping ceiling with pitched, metal roof and exposed beams.

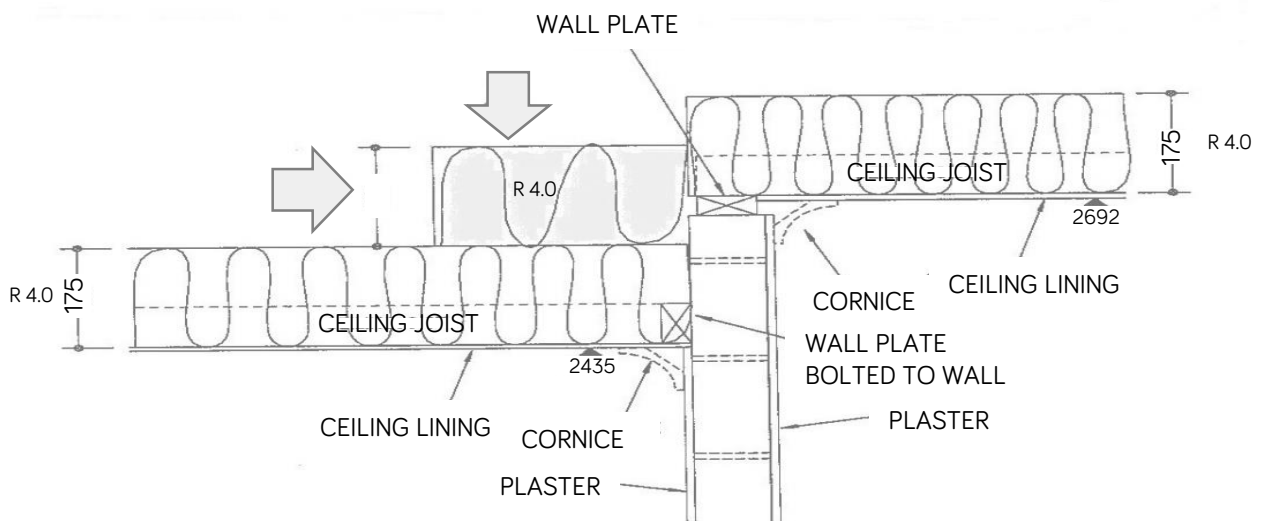
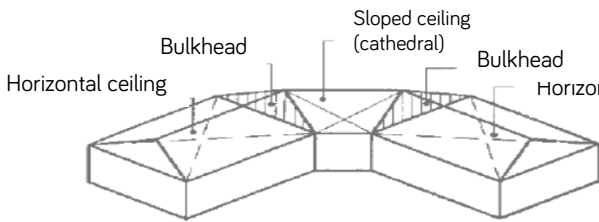

Illustration 16: Star rating requirement.

All vertical gaps in the ceiling insulation coverage area must also be filled, to comply with the 6-Star energy rating placed on new homes. These areas are usually small and are only 2 or 3 bricks high, being the difference between various course levels. You must cut strips (at least 175mm wide) and place them against the wall face, on top of our existing ceiling batts.

Do not place full batts or large pieces here, as the coverage of the joists must be kept to a minimum for safety reasons whilst still providing adequate coverage of the wall section.



(a) Multi angled construction

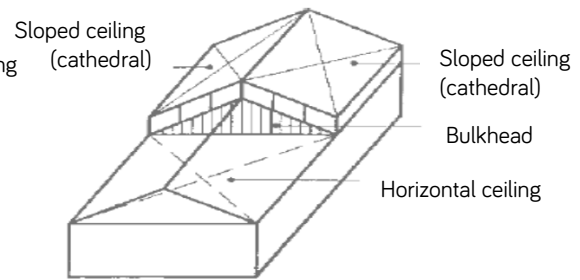

(b) Split level construction

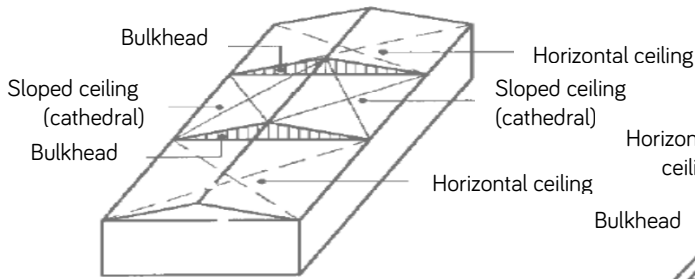

(c) Terrace construction

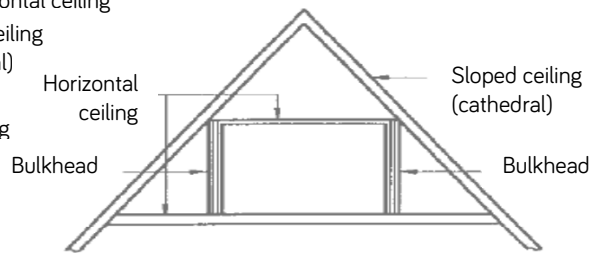

(d) Cape cod construction

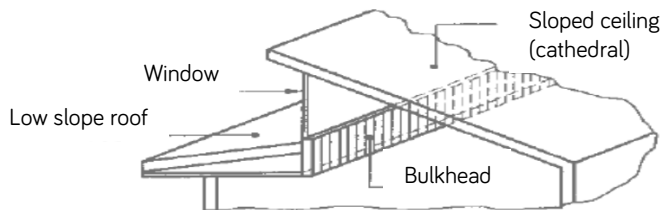

(e) Saw-tooth roof construction

Illustration 17: Examples of bulk heads.

All bulkhead areas that are in exposed via the ceilings (drop-down and coffered ceilings) must be completely covered where possible. Inaccessible areas (hidden bulkheads) need to be insulated before ceilings are installed.