



PRODUCT
INFORMATION

2025

www.mcintyresteel.com.au

McIntyre[®]

BUILDING PRODUCTS

NEW PRODUCTS

PURLIN BRACKETS



See page 20

QUICK TIES

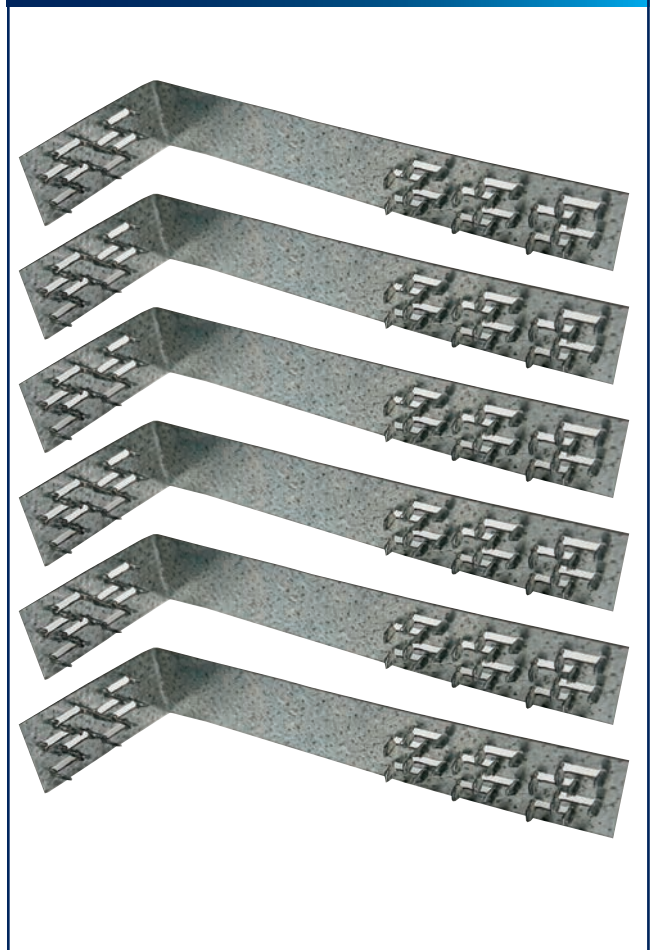

See page 9

For more information regarding any of our products please contact our office
on (03) **9311 0380**

or mail to: sales@mcintyresteel.com.au.

We'll be happy to help.

INDEX

Ant Caps	12	Multi Purpose Brackets – Zinc	16–17
Bitumen Malthoid – Dampcourse	11	Multi Purpose Brackets – Galvanised	17–20
Bitumen Alcor – Coated Aluminum	11	No Sag Easy Gate	10
Bracket Nails	7	Pergola Angle	9
Brick Ties	12	Plaster Angle	21
Damp Cor	11	Post Supports	2–4
ExFoam Expansion Foam	11	Shadetak	7
Expansion Ties	12	Sisaltak	12
Fascia Pro	8	Steel Gate Frame Kit	10
Flexembly	9	Steel Lintels – Painted	21–22
Groupnail	7	Steel Lintels – Galvanised	23–24
Hangabrackets	4–5	Sub Floor Access Doors	16
Heavy Duty HYBeam Nails	7	Timber Connectors	8–9
Holistrap	10	Vents	10
Hooknail	6	Wall & Roof Bracing	20
Hyspan & I Beam Brackets	5	Wire Ties	12
Insulation Foil & Weatherproof Wrap	11		
Metal Door Frames	13		

TO ORDER

PHONE: (03) 9311 0380
EMAIL: sales@mcintyresteel.com.au

ORDERS UNDER \$250 WILL INCUR A SURCHARGE OF \$30

A FREIGHT CHARGE OF \$15.00 APPLIES TO ALL DELIVERIES IN VICTORIA.

DEAR CUSTOMER

- To assist in the timely processing of orders, please quote the appropriate product code. Orders may be emailed to sales@mcintyresteel.com.au or phoned through on (03) 9311 0380.
- Please feel free to ask your McIntyre Building Products representative about our merchandising bins & racks.
- Brackets nails are available to suit the full range of McIntyre timber connectors, including the heavy duty range of brackets.
- Should you require more information regarding our range of products & services please phone our customer service staff on (03) 9311 0380.
- Please note that a GST of 10% applies to all purchases of McIntyre Steel products.

McIntyre Steel Industries, proud to be an Australian Owned company

McIntyre® is a Registered Trademark of McIntyre Steel Industries (Vic.) Pty. Ltd.

Post Supports

PRODUCT NAME	CODE	QTY	APN CODE
Full Stirrup – 3.75mm thick stirrup, 32mm diameter shaft, 13mm Holes			
65mm shaft x 90mm stirrup	FS65/90	10	9316101000322
65mm shaft x 100mm stirrup	FS65/100	10	9316101000315
125mm shaft x 90mm stirrup	FS125/90	10	9316101901254
125mm shaft x 100mm stirrup	FS125/100	10	9316101101258
125mm shaft x 115mm stirrup	FS125/115	10	9316101003828
125mm shaft x 125mm stirrup	FS125/125	10	9316101003798
150mm shaft x 90mm stirrup	FS150/90	10	9316101004702
150mm shaft x 100mm stirrup	FS150/100	10	9316101004719
150mm shaft x 115mm stirrup	FS150/115	10	9316101000483
150mm shaft x 120mm stirrup	FS150/120	10	9316101050136
150mm shaft x 125mm stirrup	FS150/125	10	9316101000476
150mm shaft x 150mm stirrup	FS150/150	10	9316101050044
200mm shaft x 90mm stirrup	FS200/90	10	9316101000346
200mm shaft x 100mm stirrup	FS200/100	10	9316101000339
225mm shaft x 90mm stirrup	FS225/90	10	9316101004726
225mm shaft x 100mm stirrup	FS225/100	10	9316101004733
250mm shaft x 90mm stirrup	FS250/90	10	9316101902503
250mm shaft x 100mm stirrup	FS250/100	10	9316101102507
250mm shaft x 115mm stirrup	FS250/115	10	9316101003835
250mm shaft x 120mm stirrup	FS250/120	10	9316101050273
250mm shaft x 125mm stirrup	FS250/125	10	9316101000506
300mm shaft x 90mm stirrup	FS300/90	10	9316101000360
300mm shaft x 100mm stirrup	FS300/100	10	9316101000353
300mm shaft x 115mm stirrup	FS300/115	10	9316101000520
300mm shaft x 120mm stirrup	FS300/120	10	9316101050150
300mm shaft x 125mm stirrup	FS300/125	10	9316101000513
300mm shaft x 135mm stirrup	FS300/135	10	9316101050402
300mm shaft x 150mm stirrup	FS300/150	10	9316101050051
375mm shaft x 90mm stirrup	FS375/90	10	9316101903753
375mm shaft x 100mm stirrup	FS375/100	10	9316101103757
375mm shaft x 115mm stirrup	FS375/115	10	9316101003996
375mm shaft x 120mm stirrup	FS375/120	10	9316101050167
375mm shaft x 125mm stirrup	FS375/125	10	9316101000582
375mm shaft x 135mm stirrup	FS375/135	10	9316101050419
450mm shaft x 90mm stirrup	FS450/90	10	9316101000384
450mm shaft x 100mm stirrup	FS450/100	10	9316101000377
450mm shaft x 115mm stirrup	FS450/115	10	9316101003804
450mm shaft x 125mm stirrup	FS450/125	10	9316101003811
450mm shaft x 135mm stirrup	FS450/135	10	9316101050426
450mm shaft x 150mm stirrup	FS450/150	10	9316101050068
500mm shaft x 90mm stirrup	FS500/90	10	9316101000407
500mm shaft x 100mm stirrup	FS500/100	10	9316101000391
500mm shaft x 115mm stirrup	FS500/115	10	9316101000605
500mm shaft x 120mm stirrup	FS500/120	10	9316101050174
500mm shaft x 125mm stirrup	FS500/125	10	9316101000544
600mm shaft x 90mm stirrup	FS600/90	5	9316101000421
600mm shaft x 100mm stirrup	FS600/100	5	9316101000414



90mm - 100mm Stirrups
70mm Material

115mm - 125mm Stirrups
100mm Material

135mm - 150mm Stirrups
120mm Material



Post Supports

PRODUCT NAME	CODE	QTY	APN CODE
Half Stirrup – 3.75mm thick stirrup			
65mm shaft	HSPS/65	10	9316101004740
125mm shaft	HSPS/125	10	9316101001251
200mm shaft	HSPS/200	10	9316101001800
250mm shaft	HSPS/250	10	9316101000735
300mm shaft	HSPS/300	10	9316101001817
375mm shaft	HSPS/375	10	9316101000742
500mm shaft	HSPS/500	10	9316101000759
Pin Type – 3.75mm thick bottom plate			
125mm shaft	PPS/125	10	9316101011250
150mm shaft	PPS/150	10	9316101050181
200mm shaft	PPS/200	10	9316101002074
250mm shaft	PPS/250	10	9316101000766
300mm shaft	PPS/300	10	9316101002081
375mm shaft	PPS/375	10	9316101000773
500mm shaft	PPS/500	10	9316101000780
Blade			
125mm shaft	BLPS/125	10	9316101000797
150mm shaft	BLPS/150	10	9316101003873
200mm shaft	BLPS/200	10	9316101000803
250mm shaft	BLPS/250	10	9316101000810
300mm shaft	BLPS/300	10	9316101000827
375mm shaft	BLPS/375	10	9316101000834
500mm shaft	BLPS/500	10	9316101000841
Heavy Duty Blade NEW			
125mm	IB125	1	9316101051102
150mm	IB150	1	9316101051119
Bolt On – 3.75mm stirrup & base, HDG 6x11mm/1x18mm Holes			
90mm stirrup	BOPS/90	10	9316101000865
100mm stirrup	BOPS/100	10	9316101000858
115mm stirrup	BOPS/115	10	9316101003842
120mm stirrup	BOPS/120	10	9316101050143
125mm stirrup	BOPS/125	10	9316101001961
135mm stirrup	BOPS/135	10	9316101050396
140mm Stirrup	BOPS/140	10	9316101050945
150mm stirrup	BOPS/150	10	9316101050372
200mm stirrup	BOPS/200	2	9316101051065
Bolt on Blade Post Supports 18mm Holes NEW Hot Dipped Galvanised			
110 x 110 x 8mm Base, 150 x 8mm Blade	BOBL/110	1	9316101051287
110 x 110 x 10mm Base, 290 x 10mm Blade	BOBL290/110	1	9316101051331
140 x 140 x 10mm Base, 290 x 10mm Blade	BOBL290/140	1	9316101051348
Base Cover 125x125x30x3mm suit 110 Base	BOBLCOV/110	1	9316101051652
Base Cover 150x150x30x3mm suit 140 Base	BOBLCOV/140	1	9316101051669



Bolt on Post Anchor – Galvabond – 2mm Stirrup – 3mm Base			
90mm Stirrup	GBPS90	10	9316101251366
100mm Stirrup	GBPS100	10	9316101251373

Adjustable Post Supports 75 x 4mm			
75mm shaft	ASPS/75	10	9316101000889
125mm shaft	ASPS/125	8	9316101000896

Post Supports

	CODE	QTY	APN CODE
Cyclonic			
300mm L x 50mm W, 90mm post	CY300/90	5	9316101004344
300mm L x 50mm W, 100mm post	CY300/100	5	9316101004351
450mm L x 50mm W, 90mm post	CY450/90	5	9316101004368
450mm L x 50mm W, 100mm post	CY450/100	5	9316101000902
600mm L x 50mm W, 90mm post	CY600/90	5	9316101004375
600mm L x 50mm W, 100mm post	CY600/100	5	9316101000919
600mm L x 50mm W, 125mm post	CY600/125	5	9316101004757
600mm L x 50mm W, 150mm post	CY600/150	5	9316101051058

Hangabrackets

Hangabacket 1mm			
35 x 60mm	HB3560	40	9316101000940
35 x 90mm	HB3590	40	9316101000957
35 x 120mm	HB35120	40	9316101000964
35 x 140mm	HB35140	40	9316101000971
35 x 180mm	HB35180	40	9316101002166
38 x 60mm	HB3860	40	9316101000988
38 x 90mm	HB3890	40	9316101000995
38 x 120mm	HB38120	40	9316101001008
38 x 140mm	HB38140	40	9316101001015
38 x 180mm	HB38180	40	9316101001022
38 x 220mm	HB38220	20	9316101001039
45 x 60mm	HB4560	40	9316101001046
45 x 90mm	HB4590	40	9316101001053
45 x 120mm	HB45120	40	9316101001060
45 x 140mm	HB45140	40	9316101001077
45 x 180mm	HB45180	40	9316101001084
45 x 220mm	HB45220	20	9316101001091
50 x 60mm	HB5060	40	9316101001107
50 x 90mm	HB5090	40	9315330121150
50 x 120mm	HB50120	40	9316101001114
50 x 140mm	HB50140	40	9316101001121
50 x 180mm	HB50180	40	9316101001138
50 x 220mm	HB50220	20	9316101001145

Hangabacket Stainless Steel 1mm 316			
35 x 90mm	HBSS3590	20	9316101051157
35 x 120mm	HBSS35120	20	9316101051164
35 x 140mm	HBSS35140	20	9316101051171
45 x 90mm	HBSS4590	20	9316101051188
45 x 120mm	HBSS45120	20	9316101051195
45 x 140mm	HBSS45140	20	9316101051201
45 x 180mm	HBSS45180	20	9316101051218
45 x 220mm	HBSS45220	20	9316101051225

Split Hangabacket			
180 x 1.6mm	SHB180	5	9316101051294
220 x 1.6mm	SHB220	5	9316101051300



Heavy Duty Brackets

PRODUCT NAME	CODE	QTY	APN CODE
Heavy Duty Brackets 1.2mm			
49 x 180mm	HD49180	20	9316101001909
60 x 130mm	HD60130	20	9316101001855
60 x 240mm	HD60240	20	9316101001152
65 x 170mm	HD65170	20	9316101004825
70 x 90mm	HD7090	20	9316101001879
70 x 180mm	HD70180	20	9316101001886
70 x 200mm	HD70200	20	9316101004832
75 x 220mm	HD75220	20	9316101001176
75 x 280mm	HD75280	20	9316101001183
90 x 90mm	HD9090	20	9316101050907
90 x 140mm	HD90140	20	9316101050891
90 x 200mm	HD90200	20	9316101004849
90 x 295mm	HD90295	20	9316101051324
95 x 165mm	HD95165	20	9316101001190
100 x 270mm	HD100270	20	9316101001190

Hyspan & I Beam Brackets

Hyspan Brackets – HY Series – For 45mm & 63mm sections			
48 x 195mm	HY48195	20	9316101002227
48 x 235mm	HY48235	20	9316101002234
48 x 295mm	HY48295	20	9316101002449
65 x 165mm	HY65165	20	9316101001862
65 x 195mm	HY65195	20	9316101001954
65 x 235mm	HY65235	20	9316101002241
65 x 295mm	HY65295	20	9316101002258

I Beam Brackets – Face Mounted (incl. HJ series Hybeam)			
46 x 235mm	HJ46235	20	081942032694
46 x 286mm	HJ46286	20	9316101051249
48 x 195mm	HJ48195	20	9316101001916
48 x 235mm	HJ48235	20	9316101001930
59 x 240mm	HJ59240	20	9316101001947
60 x 355mm	HJ60355	20	081942033332
65 x 295mm	HJ65295	20	9316101001978
92 x 240mm	HJ92240	20	9316101003590

I Beam Brackets – Top Mounted (incl. HJ series Hybeam)			
46 x 241mm	TM46241	25	081942031338
46 x 302mm	TM46302	25	081942012269
48 x 200mm	TM48200	25	9316101003514
48 x 240mm	TM48240	25	9316101003521
58 x 246mm	TM58246	25	9316101003538
60 x 356mm	TM60356	25	081942031352
65 x 301mm	TM65301	25	081942047018



Hooknail

PRODUCT NAME	CODE	QTY	APN CODE
Double I Beam – Face Mounted			
97 x 195mm	HJD200	20	9316101003545
97 x 235mm	HJD240	20	9316101003552
117 x 240mm	HJD246	20	9316101003569
129 x 295mm	HJD300	20	9316101003576

Hooknail 32 – 4 Series			
33mm wide x 127mm	4R4N	267	9316101004382
33mm wide x 190mm	6R4N	178	9316101004399
33mm wide x 285mm	9R4N	118	9316101004405

Hooknail 32 – 5 Series			
44mm wide x 63mm	2R5N	400	9316101004412
44mm wide x 127mm	4R5N	200	9316101004429
44mm wide x 127mm Trade Pack	4R5NT	100	9316101004436
44mm wide x 190mm	6R5N	133	9316101004443
44mm wide x 190mm Trade Pack	6R5NT	66	9316101004450
44mm wide x 222mm	7R5N	114	9316101004467
44mm wide x 254mm	8R5N	100	9316101004474
44mm wide x 317mm	10R5N	80	9316101004481



Hooknail 32 – 8 Series			
67mm wide x 63mm	2R8N	266	9316101004498
67mm wide x 127mm	4R8N	133	9316101004504
67mm wide x 127mm Trade Pack	4R8NT	66	9316101004511
67mm wide x 190mm	6R8N	88	9316101004528
67mm wide x 190mm Trade Pack	6R8NT	44	9316101004535

Hooknail 32 – 10 Series			
89mm wide x 63mm	2R10N	200	9316101004559
89mm wide x 127mm	4R10N	100	9316101004566
89mm wide x 127mm Trade Pack	4R10NT	50	9316101004573
89mm wide x 190mm	6R10N	66	9316101004580
89mm wide x 190mm Trade Pack	6R10NT	34	9316101004597
89mm wide x 254mm	8R10N	50	9316101004603
89mm wide x 254mm Trade Pack	8R10NT	26	9316101004610
89mm wide x 317mm	10R10N	40	9316101004627
89mm wide x 380mm	12R10N	33	9316101004634

Hooknail 32 – 15 Series			
133mm wide x 63mm	2R15N	133	9316101004641
133mm wide x 127mm	4R15N	66	9316101004658
133mm wide x 190mm	6R15N	44	9316101004665
133mm wide x 254mm	8R15N	33	9316101004672
133mm wide x 317mm	10R15N	27	9316101004689
133mm wide x 380mm	12R15N	22	9316101004696

Bracket Nails

PRODUCT NAME	CODE	QTY	APN CODE
30 x 2.8 Double Diameter			
Galvanised pack	NG10P	200x10	9316101001220
2kg Tub, Galvanised	NG	2kg	9316101001268
5kg Tub, Galvanised	NG5	5kg	9316101003026
Processed pack	NP10P	200x10	9316101001237
2kg Tub, Processed	NP	2kg	9316101001244
5kg Tub, Processed	NP5	5kg	9316101003033



Heavy Duty HYBeam Nails

30 x 3.15 Double Diameter			
Galvanised pack	H'NG10P	200x10	9316101002272
2kg Tub, Galvanised	H'NG	2kg	9316101002302



Groupnail

Groupnail 1mm			
25 x 100mm	GN25	300	9316101001312
50 x 100mm (Trade Pack)	GNT	100	9316101501003
50 x 100mm	GN50	200	9316101001329
75 x 100mm	GN75	150	9316101001336
100 x 100mm	GN100	100	9316101001343



Shadetak

Shadetak (12 x 50mm)			
Galvanised	STZ	500	9316101025011
Green	STG	500	9316101030015

Shadetak Prepacked			
Galvanised	STPZ	10X50	9316101132504
Green	STPG	10X50	9316101132511

Timber Connectors

Cyclone Strap 1mm			
340mm	CS34	100	9316101002104
400mm	CS40	100	9316101002111
600mm	CS60	100	9316101002128

Truss Grip 1mm			
110 x 25mm	TSGP	100	9316101004047



Timber Connectors

PRODUCT NAME	CODE	QTY	APN CODE
Batten Strap 1mm			
70mm	BS70	50	9316101050365
75mm	BS75	50	9316101001275



Heavy Duty Joistrap 1mm			
31 x 170mm – Left	HDJL	100	9316101002135
31 x 170mm – Right	HDJR	100	9316101002142



Joistrap 0.5mm			
175mm Long	JS150	150	9316101150751



Fascia Bracket			
312 x 50mm – Left	FBL	10	9316101001299
312 x 50mm – Right	FBR	10	9316101050266



Fascia Pro NEW			
External - Suit 30mm Fascia	FPEXT	5	9316101051263
Internal - Suit 30mm Fascia	FPINT	5	9316101051256
Joiner - Suit 30mm Fascia	FPJOIN	5	9316101051270

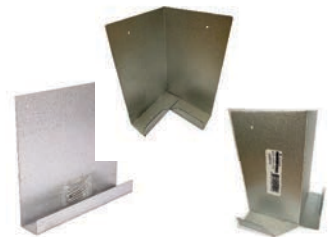

Internal Wall Bracket 0.75mm			
Trade pak – Coined 105 x 46 x 38mm	IWB	100	9316101001305



Bearer Plate 1mm			
75 x 150 mm	BP	100	9316101001282
100 x 190 mm	BP100190	30	9316101051317



Stair Bracket – Galvanised 5mm			
50 x 50 x 200mm	STBR	25	9316101004320



Ultra Heavy Duty Angle – Zinc			
40 x 40 x 230mm x 2.55mm thick	UHDA	25	9316101000490



Unibracket 1mm			
58mm	UN58	200	9316101001206
100mm	UN100	100	9316101010017
125mm	UN125	100	9316101001213



Timber Connectors

PRODUCT NAME	CODE	QTY	APN CODE
Triple Fix 1mm			
Pre-bent Right	TGR	100	9316101331006
Pre-bent Left	TGL	100	9316101771000
Pergola Angle 1.6mm			
88 x 63 x 36 x 1.6mm	PGA	100	9316101886360
Stud Ties 1mm			
150 x 90 x 150mm – For 90mm Timber	ST4U90	100	9316101004894
250 x 150 - Single Bend	ST4U	80	9316101050921
Single Sided Stud Ties 1mm			
240 x 60mm - Left	SSTL	50	9316101050952
240 x 60mm - Right	SSTR	50	9316101050969
Plate Strap 1mm			
75 x 50 x 195 x 30mm	PS	100	9316101050938
Quick Tie NEW			
185 x 70 x 30 x 1mm	QUICKTIE	50	9316101051645

Flexembly (Twin Cable - 7 x 1.6mm strands G1320 wire per cable)

PRODUCT NAME	CODE	QTY	APN CODE
2000mm Lengths	FXT200	1	9316101001541
2250mm Lengths	FXT225	1	9316101001558
2500mm Lengths	FXT250	1	9316101001565
2750mm Lengths	FXT275	1	9316101001572
3000mm Lengths	FXT300	1	9316101001589
3250mm Lengths	FXT325	1	9316101001596
3500mm Lengths	FXT350	1	9316101001602
3750mm Lengths	FXT375	1	9316101001619
4000mm Lengths	FXT400	1	9316101001626
4250mm Lengths	FXT425	1	9316101001633
4500mm Lengths	FXT450	1	9316101001640
4750mm Lengths	FXT475	1	9316101001657
5000mm Lengths	FXT500	1	9316101001664
5250mm Lengths	FXT525	1	9316101001671
5500mm Lengths	FXT550	1	9316101001688
5750mm Lengths	FXT575	1	9316101001695
6000mm Lengths	FXT600	1	9316101001701
6250mm Lengths	FXT625	1	9316101001718
6500mm Lengths	FXT650	1	9316101001725
6750mm Lengths	FXT675	1	9316101001732
7000mm Lengths	FXT700	1	9316101001749
7250mm Lengths	FXT725	1	9316101001756
7500mm Lengths	FXT750	1	9316101001763
7750mm Lengths	FXT775	1	9316101001770
8000mm Lengths	FXT800	1	9316101001787
Additional fulcrum	ADF1	1	9316101001794



Holistrap

PRODUCT NAME	CODE	QTY	APN CODE
Holistrap – 25mm x 0.6mm			
6m Punched	HS/ST6	1	9316101256064
15m Punched	HS/ST15	1	9316101251564
30m Punched	HS/ST30	1	9316101253063
50m Punched	HS/ST50	1	9316101255067

Holistrap – 25mm x 0.8mm			
6m Punched	HS/HD6	1	9316101256088
15m Punched	HS/HD15	1	9316101251588
30m Punched	HS/HD30	1	9316101253087
50m Punched	HS/HD50	1	9316101255081

Holistrap – 30mm x 0.8mm			
6m Punched	HS30/6	1	9316101306080
15m Punched	HS30/15	1	9316101301580
30m Punched	HS30/30	1	9316101303089
50m Punched	HS30/50	1	9316101305083

Holistrap – 30mm x 1.0mm			
6m Punched	HS30/HD6	1	9316101306103
15m Punched	HS30/HD15	1	9316101301511
30m Punched	HS30/HD30	1	9316101303010
50m Punched	HS30/HD50	1	9316101305014

Holistrap – 32mm x 1.2mm			
30m Punched	HSHD32/30	1	9316101050914

Holistrap: 30mm x 0.8mm Stainless Steel 316 NEW PRODUCT			
15mm Punched	HSSS30/15	1	9316101051676
30mm Punched	HSSS30/30	1	9316101051683

Holistrap: 30mm x 1.0mm Stainless Steel 316 NEW PRODUCT			
15mm Punched	HSSS30/HD15	1	9316101051690
30mm Punched	HSSS30/HD30	1	9316101051706

Holistrap Tensioners			
Holistrap Tensioners	HT	30	9316101176102
Holistrap Tensioners - Bolt Fastened	HTB	30	9316101050853

No Sag Easy Gate

Bracket Kit	NOSAG	1	066890800014
-------------	-------	---	--------------

Steel Gate Frame Kit

Steel Gate Frame 1000-1870mm High x 700-1200mm Wide	SGFR	1	9314453920015
---	------	---	---------------

Vents

Slim: 230 x 75	SLV	20	9316101001510
Slim: (230 x 88) Louvred	VSL	20	9316101001527
High: (230 x 168) Louvred	VHL	20	9316101001534

Vents – Fire Proof

Slim: 230 x 75	SLVFP	20	9316101002005
High: (230 x 168) Louvred	VHLFP	20	9316101051089



Insulation Foil & Weatherproof Wrap

PRODUCT NAME	CODE	QTY	APN CODE
Weatherproof Wrap			
Weatherproof wrap – 1,350 x 30m roll	WPW3	1	9329496000174
Weatherproof wrap – 1,350 x 60m roll	WPW6	1	9329496000167
Weatherproof Wrap – BREATHER			
Weatherproof wrap – 1,350 x 30m roll	WPB3	1	9329496000242
Weatherproof wrap – 1,350 x 60m roll	WPB6	1	9329496000235

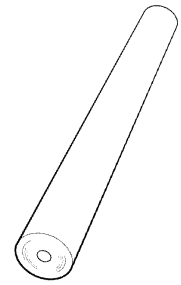

Damp Cor

Damp Cor – Polythene Dampcourse Flashing			
110mm wide x 500um x 30m	PDF110	1	9316101050075
150mm wide x 500um x 30m	PDF150	1	9316101050082
230mm wide x 500um x 30m	PDF230	1	9316101050099
300mm wide x 500um x 30m	PDF300	1	9316101050105
380mm wide x 500um x 30m	PDF380	1	9316101050112
450mm wide x 500um x 30m	PDF450	1	9316101050228



Bitumen Malthoid - Dampcourse

110mm wide x 20mt	MAL110	1	9316101050976
150mm wide x 20mt	MAL150	1	9316101050983



Alcor - 0.3mm Bitumen Coated Aluminum

230mm wide x 10mt	ALC230	1	9316101050990
300mm wide x 10mt	ALC300	1	9316101051003

Exfoam

Exfoam – Polyethylene Expansion Foam			
75mm wide x 10mm x 25m	EXF75	1	9316101050310
100mm wide x 10mm x 25m	EXF100	1	9316101050327
125mm wide x 10mm x 25m	EXF125	1	9316101050334
150mm wide x 10mm x 25m	EXF150	1	9316101050341

Exfoam – Adhesive Polyethylene Expansion Foam			
75mm wide x 10mm x 25m	EXFA75	1	9316101050808
100mm wide x 10mm x 25m	EXFA100	1	9316101050815
125mm wide x 10mm x 25m	EXFA125	1	9316101050822
150mm wide x 10mm x 25m	EXFA150	1	9316101050839



Brick Mesh

Brick Mesh (Woven) NEW			
75mm wide x 46 m	BM70	1	9316101051335



Sisaltak

PRODUCT NAME	CODE	QTY	APN CODE
Sisaltak (foil fix)			
50 strips of 10 – 23 x 25mm 4 pin	ST500	500	



Ant Caps

Ant Caps (Small)			
100mm Plain	ANP	100	9316101001435
100mm with hole	ANA	100	9316101001442
110mm 22mm side/slot & hole	ANS	100	9316101000537



Ant Caps (Large)			
100mm 50mm side	ANP/50	50	9316101001459
100mm 50mm side & hole	ANA/50	50	9316101001466
100mm 50mm side/slot & hole	ANS/50	50	9316101003729
120mm 50mm side & hole	AN12	50	9316101001473
120mm 50mm side	ANP12	50	9316101003736
225mm Half	ANH25	50	9316101001480
225mm Half, 50mm side	ANH50	50	9316101002159
225mm 25mm side & hole	AN2/25	50	9316101001497
225mm 50mm side & hole	AN2/50	50	9316101001503
225mm 50mm side	ANP2/50	50	9316101002470



Brick Ties

Slim with Nails (100mm)	BTSL	150	9316101181359
Slim with Screws (100mm)	BTSL/S	150	9316101050198
Slim Stainless with S/S Nails (100mm)	SLST	150	9316101001374
Slim Stainless with S/S Screws (100mm)	SLST/S	150	9316101050129
Standard (100mm)	BTST	150	9316101251359
Standard with Nails (100mm)	BTST/N	150	9316101050303
Frame tie (230mm)	BTFT	75	9316101230750
Slim Cavity Ties (SS) (185mm)	SLCTS	250	9316101001404



Expansion Ties

Expansion Ties (galv)	EXTG	20	9316101001411
Expansion Ties (ss)	EXTSS	20	9316101001428



Double Sleeve Expansion Ties			
Double Sleeve Exp Ties (galv w plastic slides)	CGT 1-P	50	9316101000568
Double Sleeve Exp Ties (stainless w plastic slides)	CGT 1-P SS	50	9316101000551
Double Sleeve Exp Ties (galv w galv slides)	CGT 1	50	9316101050297
Right Angle Dble Slve Exp Ties (galv w galv slides)	CGT 1-B	50	9316101050280



Wire Ties

Red/Galvanised Wire Ties			
Double Ring Cavity 180mm x 3.15mm	WTSL31R	10x50	9316035065978
Masonry Cavity 190mm x 3.15mm	WTSSB31R	5x50	9316035065909
Masonry Cavity 230mm x 4.0mm	WTHB40R	5x25	9316035065916

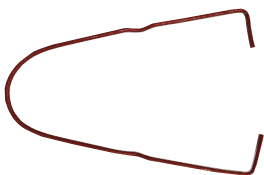

Stainless Steel (316) Wire Ties NEW			
Double Ring Cavity 180mm x 3.15mm	WTSL31RSS	4x50	9316101051577



Metal Door Frames • Wholesale price is the same for both Assembled & Unassembled

PRODUCT NAME	CODE
B93 Profile Unassembled (2055 Reveal Height) 1.2mm Zincanneal	
524 Single Left Hand 3 Hinge	B93524L3HU
524 Single Right Hand 3 Hinge	B93524R3HU
624 Single Left Hand 3 Hinge	B93624L3HU
624 Single Right Hand 3 Hinge	B93624R3HU
724 Single Left Hand 3 Hinge	B93724L3HU
724 Single Right Hand 3 Hinge	B93724R3HU
774 Single Left Hand 3 Hinge	B93774L3HU
774 Single Right Hand 3 Hinge	B93774R3HU
824 Single Left Hand 3 Hinge	B93824L3HU
824 Single Right Hand 3 Hinge	B93824R3HU
874 Single Left Hand 3 Hinge	B93874L3HU
874 Single Right Hand 3 Hinge	B93874R3HU
924 Single Left Hand 3 Hinge	B93924L3HU
924 Single Right Hand 3 Hinge	B93924R3HU
1024 Single Left Hand 3 Hinge	B931024L3HU
1024 Single Right Hand 3 Hinge	B931024R3HU
1074 Single Left Hand 3 Hinge	B931074L3HU
1074 Single Right Hand 3 Hinge	B931074R3HU
1246 Double 6 Hinge	B9312466HU
1446 Double 6 Hinge	B9314466HU
1546 Double 6 Hinge	B9315466HU
1646 Double 6 Hinge	B9316466HU
1746 Double 6 Hinge	B9317466HU
1846 Double 6 Hinge	B9318466HU
2046 Double 6 Hinge	B9320466HU

PRODUCT NAME	CODE
B102 Profile Unassembled (2055 Reveal Height) 1.2mm Zincanneal	
524 Single Left Hand 3 Hinge	B102524L3HU
524 Single Right Hand 3 Hinge	B102524R3HU
624 Single Left Hand 3 Hinge	B102624L3HU
624 Single Right Hand 3 Hinge	B102624R3HU
724 Single Left Hand 3 Hinge	B102724L3HU
724 Single Right Hand 3 Hinge	B102724R3HU
774 Single Left Hand 3 Hinge	B102774L3HU
774 Single Right Hand 3 Hinge	B102774R3HU
824 Single Left Hand 3 Hinge	B102824L3HU
824 Single Right Hand 3 Hinge	B102824R3HU
874 Single Left Hand 3 Hinge	B102874L3HU
874 Single Right Hand 3 Hinge	B102874R3HU
924 Single Left Hand 3 Hinge	B102924L3HU
924 Single Right Hand 3 Hinge	B102924R3HU
1024 Single Left Hand 3 Hinge	B1021024L3HU
1024 Single Right Hand 3 Hinge	B1021024R3HU
1074 Single Left Hand 3 Hinge	B1021074L3HU
1074 Single Right Hand 3 Hinge	B1021074R3HU
1246 Double 6 Hinge	B10212466HU
1446 Double 6 Hinge	B10214466HU
1546 Double 6 Hinge	B10215466HU
1646 Double 6 Hinge	B10216466HU
1746 Double 6 Hinge	B10217466HU
1846 Double 6 Hinge	B10218466HU
2046 Double 6 Hinge	B10220466HU

PRODUCT NAME	CODE
B114 Profile Unassembled (2055 Reveal Height) 1.2mm Zincanneal	
524 Single Left Hand 2 Hinge	B114524L2HU
524 Single Right Hand 2 Hinge	B114524R2HU
624 Single Left Hand 2 Hinge	B114624L2HU
624 Single Right Hand 2 Hinge	B114624R2HU
724 Single Left Hand 3 Hinge	B114724L3HU
724 Single Right Hand 3 Hinge	B114724R3HU
774 Single Left Hand 3 Hinge	B114774L3HU
774 Single Right Hand 3 Hinge	B114774R3HU
824 Single Left Hand 3 Hinge	B114824L3HU
824 Single Right Hand 3 Hinge	B114824R3HU
874 Single Left Hand 3 Hinge	B114874L3HU
874 Single Right Hand 3 Hinge	B114874R3HU
924 Single Left Hand 3 Hinge	B114924L3HU
924 Single Right Hand 3 Hinge	B114924R3HU
1024 Single Left Hand 3 Hinge	B1141024L3HU
1024 Single Right Hand 3 Hinge	B1141024R3HU
1074 Single Left Hand 3 Hinge	B1141074L3HU
1074 Single Right Hand 3 Hinge	B1141074R3HU
1246 Double 6 Hinge	B11412466HU
1446 Double 6 Hinge	B11414466HU
1546 Double 6 Hinge	B11415466HU
1646 Double 6 Hinge	B11416466HU
1746 Double 6 Hinge	B11417466HU
1846 Double 6 Hinge	B11418466HU
2046 Double 6 Hinge	B11420466HU

PRODUCT NAME	CODE
B114 Profile Unassembled (2355 Reveal Height) 1.2mm Zincanneal	
524 Single Left Hand 3 Hinge	B114524L3HUS1
524 Single Right Hand 3 Hinge	B114524R3HUS1
624 Single Left Hand 3 Hinge	B114624L3HUS1
624 Single Right Hand 3 Hinge	B114624R3HUS1
724 Single Left Hand 3 Hinge	B114724L3HUS1
724 Single Right Hand 3 Hinge	B114724R3HUS1
774 Single Left Hand 3 Hinge	B114774L3HUS1
774 Single Right Hand 3 Hinge	B114774R3HUS1
824 Single Left Hand 3 Hinge	B114824L3HUS1
824 Single Right Hand 3 Hinge	B114824R3HUS1
874 Single Left Hand 3 Hinge	B114874L3HUS1
874 Single Right Hand 3 Hinge	B114874R3HUS1
924 Single Left Hand 3 Hinge	B114924L3HUS1
924 Single Right Hand 3 Hinge	B114924R3HUS1
1024 Single Left Hand 3 Hinge	B1141024L3HUS1
1024 Single Right Hand 3 Hinge	B1141024R3HUS1
1074 Single Left Hand 3 Hinge	B1141074L3HUS1
1074 Single Right Hand 3 Hinge	B1141074R3HUS1
1246 Double 6 Hinge	B11412466HUS1
1446 Double 6 Hinge	B11414466HUS1
1546 Double 6 Hinge	B11415466HUS1
1646 Double 6 Hinge	B11416466HUS1
1746 Double 6 Hinge	B11417466HUS1
1846 Double 6 Hinge	B11418466HUS1
2046 Double 6 Hinge	B11420466HUS1

Metal Door Frames

PRODUCT NAME	CODE
B123 Profile Unassembled (2055 Reveal Height) 1.2mm Zincanneal	
524 Single Left Hand 3 Hinge	B123524L3HU
524 Single Right Hand 3 Hinge	B123524R3HU
624 Single Left Hand 3 Hinge	B123624L3HU
624 Single Right Hand 3 Hinge	B123624R3HU
724 Single Left Hand 3 Hinge	B123724L3HU
724 Single Right Hand 3 Hinge	B123724R3HU
774 Single Left Hand 3 Hinge	B123774L3HU
774 Single Right Hand 3 Hinge	B123774R3HU
824 Single Left Hand 3 Hinge	B123824L3HU
824 Single Right Hand 3 Hinge	B123824R3HU
874 Single Left Hand 3 Hinge	B123874L3HU
874 Single Right Hand 3 Hinge	B123874R3HU
924 Single Left Hand 3 Hinge	B123924L3HU
924 Single Right Hand 3 Hinge	B123924R3HU
1024 Single Left Hand 3 Hinge	B1231024L3HU
1024 Single Right Hand 3 Hinge	B1231024R3HU
1074 Single Left Hand 3 Hinge	B1231074L3HU
1074 Single Right Hand 3 Hinge	B1231074R3HU
1246 Double 6 Hinge	B12312466HU
1446 Double 6 Hinge	B12314466HU
1546 Double 6 Hinge	B12315466HU
1646 Double 6 Hinge	B12316466HU
1746 Double 6 Hinge	B12317466HU
1846 Double 6 Hinge	B12318466HU
2046 Double 6 Hinge	B12320466HU

PRODUCT NAME	CODE
B146 Profile Unassembled (2055 Reveal Height) 1.2mm Zincanneal	
524 Single Left Hand 3 Hinge	B146524L3HU
524 Single Right Hand 3 Hinge	B146524R3HU
624 Single Left Hand 3 Hinge	B146624L3HU
624 Single Right Hand 3 Hinge	B146624R3HU
724 Single Left Hand 3 Hinge	B146724L3HU
724 Single Right Hand 3 Hinge	B146724R3HU
774 Single Left Hand 3 Hinge	B146774L3HU
774 Single Right Hand 3 Hinge	B146774R3HU
824 Single Left Hand 3 Hinge	B146824L3HU
824 Single Right Hand 3 Hinge	B146824R3HU
874 Single Left Hand 3 Hinge	B146874L3HU
874 Single Right Hand 3 Hinge	B146874R3HU
924 Single Left Hand 3 Hinge	B146924L3HU
924 Single Right Hand 3 Hinge	B146924R3HU
1024 Single Left Hand 3 Hinge	B1461024L3HU
1024 Single Right Hand 3 Hinge	B1461024R3HU
1074 Single Left Hand 3 Hinge	B1461074L3HU
1074 Single Right Hand 3 Hinge	B1461074R3HU
1246 Double 6 Hinge	B14612466HU
1446 Double 6 Hinge	B14614466HU
1546 Double 6 Hinge	B14615466HU
1646 Double 6 Hinge	B14616466HU
1746 Double 6 Hinge	B14617466HU
1846 Double 6 Hinge	B14618466HU
2046 Double 6 Hinge	B14620466HU

PRODUCT NAME	CODE
B194 Profile Unassembled (2055 Reveal Height) 1.2mm Zincanneal	
524 Single Left Hand 3 Hinge	B194524L3HU
524 Single Right Hand 3 Hinge	B194524R3HU
624 Single Left Hand 3 Hinge	B194624L3HU
624 Single Right Hand 3 Hinge	B194624R3HU
724 Single Left Hand 3 Hinge	B194724L3HU
724 Single Right Hand 3 Hinge	B194724R3HU
774 Single Left Hand 3 Hinge	B194774L3HU
774 Single Right Hand 3 Hinge	B194774R3HU
824 Single Left Hand 3 Hinge	B194824L3HU
824 Single Right Hand 3 Hinge	B194824R3HU
874 Single Left Hand 3 Hinge	B194874L3HU
874 Single Right Hand 3 Hinge	B194874R3HU
924 Single Left Hand 3 Hinge	B194924L3HU
924 Single Right Hand 3 Hinge	B194924R3HU
1024 Single Left Hand 3 Hinge	B1941024L3HU
1024 Single Right Hand 3 Hinge	B1941024R3HU
1074 Single Left Hand 3 Hinge	B1941074L3HU
1074 Single Right Hand 3 Hinge	B1941074R3HU
1246 Double 6 Hinge	B19412466HU
1446 Double 6 Hinge	B19414466HU
1546 Double 6 Hinge	B19415466HU
1646 Double 6 Hinge	B19416466HU
1746 Double 6 Hinge	B19417466HU
1846 Double 6 Hinge	B19418466HU
2046 Double 6 Hinge	B19420466HU

PRODUCT NAME	CODE
B230 Profile Unassembled (2055 Reveal Height) 1.2mm Zincanneal	
524 Single Left Hand 3 Hinge	B230524L3HU
524 Single Right Hand 3 Hinge	B230524R3HU
624 Single Left Hand 3 Hinge	B230624L3HU
624 Single Right Hand 3 Hinge	B230624R3HU
724 Single Left Hand 3 Hinge	B230724L3HU
724 Single Right Hand 3 Hinge	B230724R3HU
774 Single Left Hand 3 Hinge	B230774L3HU
774 Single Right Hand 3 Hinge	B230774R3HU
824 Single Left Hand 3 Hinge	B230824L3HU
824 Single Right Hand 3 Hinge	B230824R3HU
874 Single Left Hand 3 Hinge	B230874L3HU
874 Single Right Hand 3 Hinge	B230874R3HU
924 Single Left Hand 3 Hinge	B230924L3HU
924 Single Right Hand 3 Hinge	B230924R3HU
1024 Single Left Hand 3 Hinge	B2301024L3HU
1024 Single Right Hand 3 Hinge	B2301024R3HU
1074 Single Left Hand 3 Hinge	B2301074L3HU
1074 Single Right Hand 3 Hinge	B2301074R3HU
1246 Double 6 Hinge	B23012466HU
1446 Double 6 Hinge	B23014466HU
1546 Double 6 Hinge	B23015466HU
1646 Double 6 Hinge	B23016466HU
1746 Double 6 Hinge	B23017466HU
1846 Double 6 Hinge	B23018466HU
2046 Double 6 Hinge	B23020466HU

Metal Door Frames

PRODUCT NAME	CODE
BP194 Profile Assembled (2065 Reveal Height)	
824 Single Left Hand 3 Hinge, Welded Seams	BP194824L3HA
824 Single Right Hand 3 Hinge, Welded Seams	BP194824R3HA
1646 Double 6 Hinge, Welded Seams	BP19416466HA

PRODUCT NAME	CODE
Stud Fix Brackets	
S/Clip 10mm Plaster	S/Clip 10
S/Clip 13mm Plaster	S/Clip 13
S/Clip 16mm Plaster	S/Clip 16
Dynabolt option For fixing to existing brickwork or concrete	D/Bolt 6
Screw Prep Option For fixing to stud work	S/Prep
Welded Mitre Joins	WM
Backing Plates	BACKING PLATE
Strap Fix	STRAP FIX

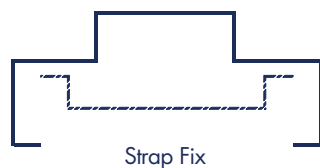
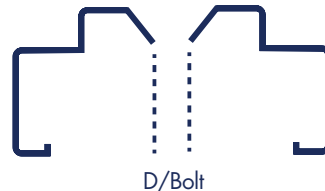
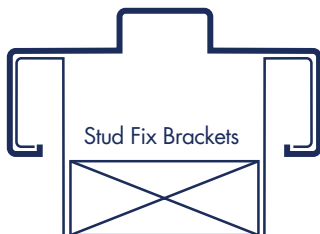
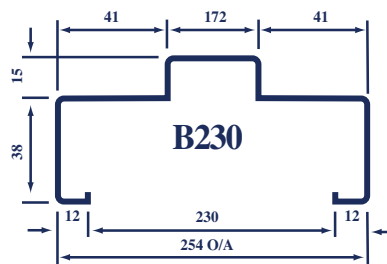
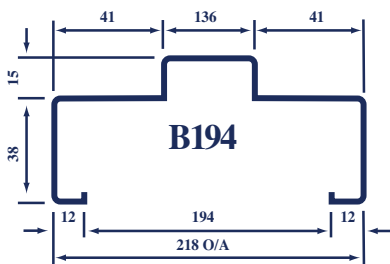
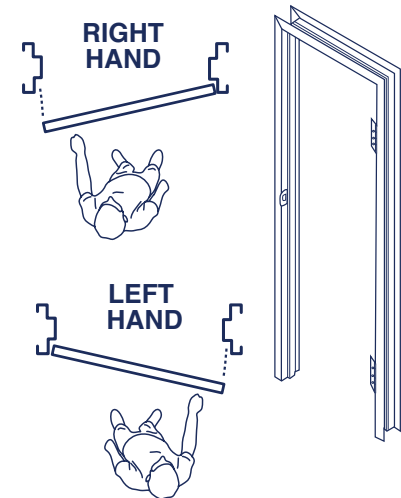
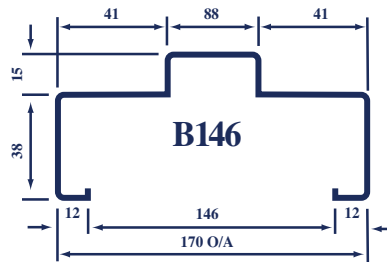
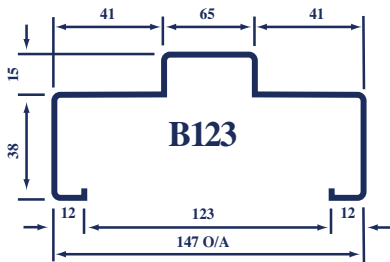
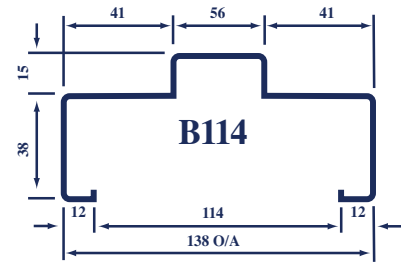
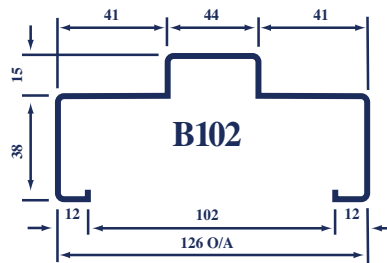
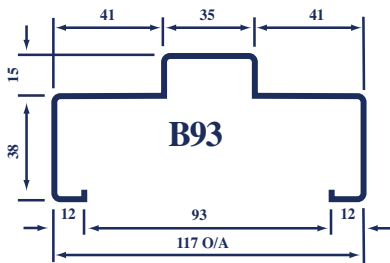

Available on request:
 Custom made Frames.
 Fire Rated Frames.
 Fire Rated Doors.
 Metal Clad Doors.

**Assembled Frames cannot be returned*

Sub Floor Access Doors 75 x 5 x 900mm Top Cord, 40 x 5 x 900mm Bottom Cord

PRODUCT NAME	CODE	QTY	APN CODE
Access Doors with Painted Frames			
725mm wide x 434mm high	ACD434	1	9316101003422
725mm wide x 520mm high	ACD520	1	9316101003439
725mm wide x 692mm high	ACD692	1	9316101003446
725mm wide x 863mm high	ACD863	1	9316101003453
725mm wide x 1292mm high	ACD1292	1	9316101003460



Access Doors with Galvanised Frames			
725mm wide x 434mm high	ACD434G	1	9316101003477
725mm wide x 520mm high	ACD520G	1	9316101003484
725mm wide x 692mm high	ACD692G	1	9316101003491
725mm wide x 863mm high	ACD863G	1	9316101003507
725mm wide x 1292mm high	ACD1292G	1	9316101003095



Multi Purpose Brackets – Zinc

Fencing Bracket – M6 Holes			
100 x 40 x 32 x 3mm	MFO082	50	9316101003903



Fence Plates – M8 Holes			
85 x 32 x 3mm – 2 Holes	MFO079	50	9316101003880
140 x 32 x 3mm – 3 Holes	MFO080	50	9316101003897



Corner Bracket – M8 Holes			
72 x 72 x 32 x 3mm	MFO081	50	9316101003682



Shelf Angle Bracket – M6 Holes (x4)			
100 x 75 x 20 x 5mm	MFO223	10	9316101003705
125 x 100 x 20 x 5mm	MFO224	10	9316101003712
150 x 125 x 20 x 5mm	MFO225	10	9316101003972
200 x 150 x 20 x 5mm	MFO226	10	9316101003163
250 x 200 x 20 x 5mm	MFO227	10	9316101003170



Angle Bracket – M6 Holes (x4)			
40 x 40 x 40 x 3mm	MFO228	50	9316101003118
50 x 50 x 40 x 3mm	MFO229	50	9316101003125
75 x 75 x 40 x 3mm (Light use)	MFO230	50	9316101050006
100 x 100 x 40 x 3mm	MFO231	50	9316101003088
50 x 50 x 40 x 5mm	MFO232	50	9316101003132
100 x 100 x 40 x 6mm	MFO234	50	9316101003156
150 x 150 x 40 x 5mm	MFO235	50	9316101003651
200 x 200 x 40 x 5mm	MFO236	50	9316101003688



Multi Purpose Brackets – Zinc

PRODUCT NAME	CODE	QTY	APN CODE
Angle Bracket (x4)			
100 x 75 x 6mm (8mm holes)	MFO083	10	9316101003927
75 x 75 x 6mm (10mm holes)	MFO084	10	9316101003675



Timber Angle Bracket M18 Holes NEW			
100 x 100 x 200 x 8mm (x 6 Holes) Painted	MTA118P	1	9316101051232
100 x 100 x 200 x 6mm (x 6 Holes) Painted	MTA116P	1	

Angle Bracket – M8 Holes (x2)			
45 x 45 x 32 x 3mm	MFO094	50	9316101003910

Angle Bracket with Stay – M6 Holes (x4)			
200 x 200 x 25 x 5mm	MFO214	10	9316101003187
250 x 200 x 25 x 5mm	MFO215	10	9316101003194
250 x 250 x 25 x 5mm	MFO216	10	9316101003200
300 x 200 x 25 x 5mm	MFO217	10	9316101003217
300 x 300 x 25 x 5mm	MFO218	10	9316101003224
350 x 250 x 25 x 5mm	MFO219	10	9316101003965
350 x 350 x 25 x 5mm	MFO220	10	9316101003231
400 x 250 x 25 x 5mm	MFO221	10	9316101003248
500 x 400 x 25 x 5mm	MFO222	10	9316101003255



Multi Purpose Bracket Range – Galvanised

Fence Plinth Bracket – M6 Holes (x4)			
120 x 35 x 35 x 1mm	FPBG	100	9316101050020



Fence Rail Bracket – M6 Holes (x5)			
111 x 60 x 65 x 35 x 2mm	FRBG	100	9316101050037



Angle Bracket – (x2 holes)			
40 x 40 x 40 x 5mm - 10mm Holes	MFO212G	50	9316101004054
40 x 40 x 40 x 5mm - 12mm Holes	MFO200G	50	9316101004061
50 x 50 x 50 x 5mm - 10mm Holes	MFO213G	50	9316101004337
50 x 50 x 50 x 5mm - 12mm Holes	MFO201G	50	9316101004078
65 x 65 x 65 x 5mm - 12mm Holes	MFO202G	50	9316101004085
90 x 90 x 75 x 6mm - 12mm Holes	MFO203G	10	9316101004108
100 x 100 x 50 x 8mm - 14mm Holes	MFO118G	10	9316101051072



Angle Bracket – M12 holes (x 3)			
40 x 80 x 40 x 5mm	MFO204G	50	9316101050488
50 x 100 x 50 x 5mm	MFO205G	50	9316101003934
65 x 130 x 65 x 5mm	MFO206G	25	9316101003941
90 x 150 x 75 x 6mm	MFO207G	10	9316101003958



Angle Bracket – M12 holes (x 4)			
80 x 80 x 40 x 5mm	MFO208G	50	9316101004092
100 x 100 x 50 x 5mm	MFO209G	50	9316101004115
130 x 130 x 65 x 5mm	MFO210G	10	9316101004122
150 x 150 x 75 x 6mm	MFO211G	10	9316101003101



Multi Purpose Bracket Range – Galvanised

PRODUCT NAME	CODE	QTY	APN CODE
Angle Bracket – M10 holes (x4)			
80 x 80 x 40 x 5mm	MFO20841G	50	9316101050846
100 x 100 x 50 x 5mm	MFO20941G	50	9316101050495
150 x 150 x 75 x 6mm	MFO21141G	20	9316101050501



Purlin C100 Angle Bracket – M10 Holes (x6)			
106 x 65 x 52 x 3mm	MFA100G	50	9316101003262

Purlin P100 Angle Bracket Plate – M10 Holes (x2)			
95 x 51 x 3mm	MFP100G	50	9316101003279



Purlin C150 Angle Bracket – M10 Holes (x4)			
145 x 50 x 50 x 3mm	MFA150G	50	9316101050013

Purlin P150 Angle Bracket Plate – M10 Holes (x2)			
145 x 49 x 3mm	MFP150G	50	9316101003309

Purlin C200 Angle Bracket – M10 Holes (x4)			
195 x 65 x 65 x 3mm	MFA200G	25	9316101004030



Purlin P200 Angle Bracket Plate – M10 Holes (x2)			
192 x 65 x 3mm	MFP200G	50	9316101003316

Bond Beam Truss Bracket (x2 holes)			
200 x 50 x 6mm (14 & 17mm holes)	MBB2001417G	25	9316101003323
200 x 50 x 6mm (14 & 19mm holes)	MBB2001419G	25	9316101003385

Steel Post Inner Bracket – M10 Holes (x4)			
45 x 42 x 45 x 3mm – M10 Holes (x1)	MFPS50G	50	9316101003392
60 x 45 x 60 x 3mm – M10 Holes (x1)	MFPS65G	50	9316101003408
70 x 45 x 70 x 3mm – M10 Holes (x1)	MFPS75G	50	9316101003415
85 x 80 x 85 x 3mm – M10 Holes (x4)	MFPS90G	50	9316101002289



Multi Purpose Bracket Range – Galvanised

PRODUCT NAME	CODE	QTY	APN CODE
Angle Bracket – M6 holes (x4)			
50 x 50 x 40 x 5mm	MFO232G	50	9316101050433
75 x 75 x 40 x 5mm	MFO233G	50	9316101050440
100 x 100 x 40 x 5mm	MFO234G	50	9316101050457
150 x 150 x 40 x 5mm	MFO235G	25	9316101050464
200 x 200 x 40 x 5mm	MFO236G	25	9316101050471



Timber Angle Brkt – M12 holes (x4)			
125 x 65 x 65 x 6mm	MTA125G	20	9316101050518



Timber Angle Brkt – M18 holes (x6)			
100 x 100 x 200 x 8mm	MTA118G	5	9316101051232
150 x 150 x 240 x 10mm	MTA2415G	1	9316101051713
150 x 150 x 140 x 10mm	MTA1415G	1	9316101051720

Timber Angle Brkt – M12 holes (x8)			
190 x 75 x 50 x 6mm	MTA190G	10	9316101050525
240 x 75 x 50 x 6mm	MTA240G	10	9316101050532
290 x 75 x 50 x 6mm	MTA290G	10	9316101050549
240 x 100 x 100 x 10mm (M14 holes)	MTA110G	5	9316101051096



Flat Timber Brkt – M6 holes			
100 x 50 x 3mm	MFT1503G	50	9316101050556
200 x 50 x 3mm	MFT2503G	50	9316101050563
300 x 50 x 5mm	MFT3505G	25	9316101050570



Flat Timber Brkt – M12 holes			
150 x 75 x 5mm	MFT1755G	25	9316101050587



Shelf Angle Brkt – M6 holes (x 4)			
100 x 75 x 20 x 5mm	MFO223G	10	9316101050594
125 x 100 x 20 x 5mm	MFO224G	10	9316101050600
150 x 125 x 20 x 5mm	MFO225G	10	9316101050617
200 x 150 x 20 x 5mm	MFO226G	10	9316101050624
250 x 200 x 20 x 5mm	MFO227G	10	9316101050631



Shelf Angle Brkt w Stay – M6 holes (x4)			
200 x 200 x 25 x 5mm	MFO214G	10	9316101050648
250 x 200 x 25 x 5mm	MFO215G	10	9316101050655
250 x 250 x 25 x 5mm	MFO216G	10	9316101050662
300 x 200 x 25 x 5mm	MFO217G	10	9316101050679
300 x 300 x 25 x 5mm	MFO218G	10	9316101050686
350 x 250 x 25 x 5mm	MFO219G	10	9316101050693
350 x 350 x 25 x 5mm	MFO220G	10	9316101050709
400 x 250 x 25 x 5mm	MFO221G	10	9316101050716
500 x 400 x 25 x 5mm	MFO222G	10	9316101050723



Multi Purpose Bracket Range – Galvanised

PRODUCT NAME	CODE	QTY	APN CODE
Heavy Duty Shelf Angle Brkt w Stay – M12 holes (x4)			
400 x 300 x 50 x 5mm	HMFO223G	10	9316101050730
500 x 400 x 50 x 5mm	HMFO224G	10	9316101050747



Timber Angle Bracket – M12 holes (x4)			
210 x 60 x 50 x 6mm	MTB2106G	20	9316101050754
210 x 130 x 50 x 6mm	MTB2113G	20	9316101050761
280 x 60 x 50 x 6mm	MTB2806G	20	9316101050778



L Timber Bracket – M6 holes (x9)			
190 x 190 x 40 x 5mm	MTL190G	25	9316101050785

T Timber Bracket – M6 holes (x9)			
190 x 190 x 40 x 5mm	MTT190G	25	9316101050792

Purlin Brackets - Raw - 2 holes 22 x 11mm			
50 x 90 x 55 x 3mm	PB55	50	9316101051607
50 x 90 x 105 x 3mm	PB105	30	9316101051591
50 x 90 x 155 x 3mm	PB155	20	9316101051584

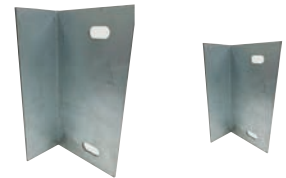

Purlin Brackets - Galv - 2 holes 22 x 11mm			
50 x 90 x 55 x 3mm	PB55G	50	9316101051638
50 x 90 x 105 x 3mm	PB105G	30	9316101051621
50 x 90 x 155 x 3mm	PB155G	20	9316101051614



Wall & Roof Bracing

PRODUCT NAME	CODE	QTY
Wallbrace		
3.0 Metre lengths	WB30	10
3.3 Metre lengths	WB33	10
3.6 Metre lengths	WB36	10
3.9 Metre lengths	WB39	10
4.2 Metre lengths	WB42	10
4.5 Metre lengths	WB45	10
4.8 Metre lengths	WB48	10



Maxibrace		
3.6 Metre lengths	MX36	10
4.2 Metre lengths	MX42	10
4.8 Metre lengths	MX48	10

Roofbrace		
3.0 Metre lengths	RB30	10
3.6 Metre lengths	RB36	10
4.0 Metre lengths	RB40	10
5.0 Metre lengths	RB50	10
6.0 Metre lengths	RB60	10



Plaster Angle

PRODUCT NAME	CODE	QTY
Plaster Angle		
Internal (unpncd 2.4m Lgth) 30x30mm	IPA	20
External 2.4m Lengths 30x30mm	EPA	20
External 2.7m Lengths 30x30mm	EPA27	20

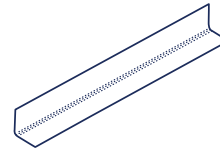

Steel Lintels – Painted (Price per metre)

PRODUCT NAME	CODE
Flats	
75 x 6 mm Flat	FL756P
75 x 8 mm Flat	FL758P
75 x 10 mm Flat	FL7510P

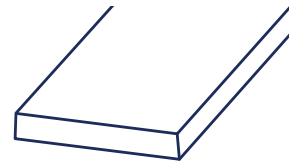

Angles

100 x 75 x 6 mm Angle	UA100756P
100 x 100 x 6 mm Angle	EA1001006P
100 x 100 x 8 mm Angle	EA1001008P
100 x 100 x 10 mm Angle	EA10010010P
150 x 90 x 8 mm Angle	UA150908P
150 x 100 x 10 mm Angle	UA15010010P

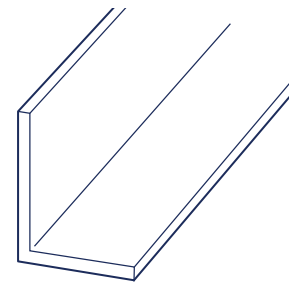

T-Bars

200 x 200 x 6 mm Tee	TB20062006P
200 x 200 x 8 mm Tee	TB20082008P
200 x 200 x 10 mm Tee	TB2001020010P
200 x 200 x 12 mm Tee	TB2001220012P
200 x 10 H x 250 x 10 mm V Tee	TB2001025010P
200 x 6 H x 150 x 10 mm V Tee	TB200615010P
200 x 6 H x 200 x 8 mm V Tee	TB20062008P
200 x 8 H x 150 x 8 mm V Tee	TB20081508P
200 x 10 H x 200 x 6 mm V Tee	TB200102006P
200 x 10 H x 200 x 8 mm V Tee	TB200102008P
200 x 10 H x 150 x 10 mm V Tee	TB2001015010P
200 x 10 H x 200 x 12 mm V Tee	TB2001020012P
200 x 10 H x 250 x 12 mm V Tee	TB2001025012P
200 x 12 H x 250 x 12 mm V Tee	TB2001225012P

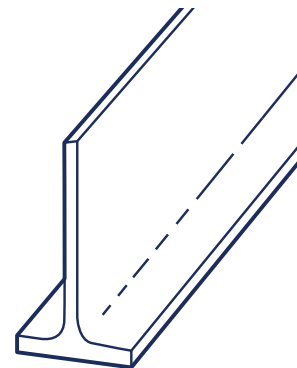

Steel Lintels – Painted (Price per metre)

PRODUCT NAME	CODE
Beams	
150 UB 14	UB15014P
150 UB 18	UB15018P
180 UB 16	UB18016P
180 UB 18	UB18018P
180 UB 22	UB18022P
200 UB 18	UB20018P
200 UB 22	UB20022P
200 UB 25	UB20025P
200 UB 30	UB20030P
250 UB 26	UB25026P
250 UB 31	UB25013P
250 UB 37	UB25037P

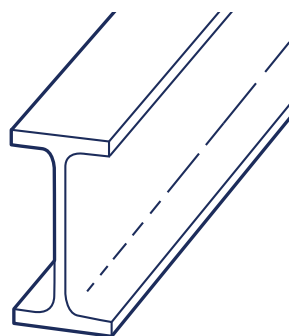

Channels	
100 x 50 mm PFC	CH100P
125 x 65 mm PFC	CH125P
150 x 75 mm PFC	CH150P
180 x 75 mm PFC	CH180P
200 x 75 mm PFC	CH200P
230 x 75 mm PFC	CH230P
250 x 90 mm PFC	CH250P
300 x 90 mm PFC	CH300P
380 x 100 mm PFC	CH380P

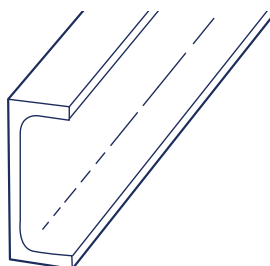

Universal Columns	
97 x 99 mm UC	UC10015P
152 x 152 mm UC	UC15024P

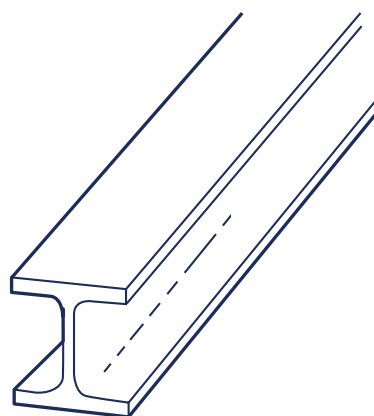

Steel Lintels – Galvanised (Price per metre)

Flats	
75 x 6 mm Flat	FL756G
75 x 8 mm Flat	FL758G
75 x 10 mm Flat	FL7510G

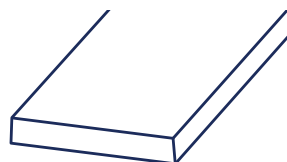

Steel Lintels – Galvanised (Price per metre)

PRODUCT NAME	CODE
Angles	
100 x 75 x 6 mm Angle	UA100756G
100 x 100 x 6 mm Angle	EA1001006G
100 x 100 x 8 mm Angle	EA1001008G
100 x 100 x 10 mm Angle	EA10010010G
150 x 90 x 8 mm Angle	UA150908G
150 x 100 x 10 mm Angle	UA15010010G

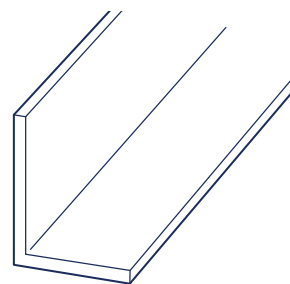

T-Bars	
200 x 200 x 6 mm Tee	TB20062006G
200 x 200 x 8 mm Tee	TB20082008G
200 x 200 x 10 mm Tee	TB2001020010G
200 x 200 x 12 mm Tee	TB2001220012G
200 x 10 H x 250 x 10 mm V Tee	TB2001025010G
200 x 6 H x 150 x 10 mm V Tee	TB200615010G
200 x 6 H x 200 x 8 mm V Tee	TB20062008G
200 x 8 H x 150 x 8 mm V Tee	TB20081508G
200 x 10 H x 200 x 6 mm V Tee	TB200102006G
200 x 10 H x 200 x 8 mm V Tee	TB200102008G
200 x 10 H x 150 x 10 mm V Tee	TB2001015010G
200 x 10 H x 200 x 12 mm V Tee	TB2001020012G
200 x 10 H x 250 x 12 mm V Tee	TB2001025012G
200 x 12 H x 250 x 12 mm V Tee	TB2001225012G

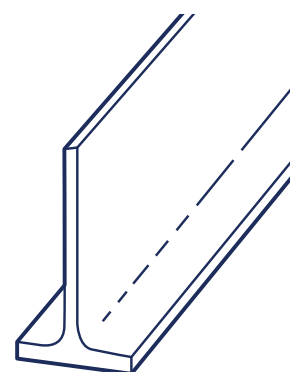

Beams	
150 UB 14	UB15014G
150 UB 18	UB15018G
180 UB 16	UB18016G
180 UB 18	UB18018G
180 UB 22	UB18022G
200 UB 18	UB20018G
200 UB 22	UB20022G
200 UB 25	UB20025G
200 UB 30	UB20030G
250 UB 26	UB25026G
250 UB 31	UB25013G
250 UB 37	UB25037G

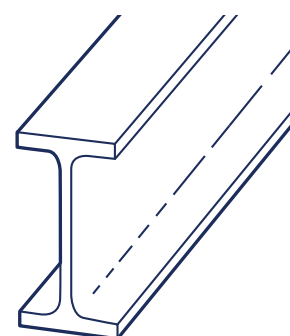

Steel Lintels – Galvanised (Price per metre)

PRODUCT NAME	CODE
Channels	
100 x 50 mm PFC	CH100G
125 x 65 mm PFC	CH1 25G
150 x 75 mm PFC	CH1 50G
180 x 75 mm PFC	CH1 80G
200 x 75 mm PFC	CH2 00G
230 x 75 mm PFC	CH2 30G
250 x 90 mm PFC	CH2 50G
300 x 90 mm PFC	CH3 00G
380 x 100 mm PFC	CH380G

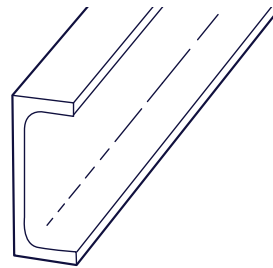

Universal Columns	
97 x 99 mm UC	UC10015G
152 x 152 mm UC	UC15024G

